

CableEye® Catalog

Large photos of all items: camiresearch.com/catalog

SINCE
93
Providing
Reliable Tests Solutions

CAMI Research

Edition of Oct 18, 2024
Prices subject to change without notice.

Table of Contents

The CableEye System	
The CableEye Tester	2
The CableEye Software	3
System Selection Guide	
Find the Right CableEye Tester for Your Needs	4
Systems	
M2 Tester	5
M3 Series Testers	6
M4 Tester	7
HVX High Voltage (HiPot) Testers	10
Technical Specifications	13
Expansion Modules	
M3 and M4 Expansion Modules	8
256-Point Special Offer	9
Quickmount™ System	9
Standard Connector Boards	
Index, Key	14
Connector Boards	14-29
Training, Validation and Verification Boards	
CB-T1, CB50A, CB52, and CB58	30
Custom Interface Fixtures	
LIF, ZIF Fixtures	30-31
Custom Interface Development	32
Light-Guided Connector Assembly	
CB Boards 37A to 38A	34-35
Optional Software	
Selection Guide	36
Custom Interfacing, Graphics, Pin Labels	37
Custom Reporting and Labeling	38
Standalone Software License	38
Export/Import	39
API for Visual Basic® and LabView™ Software	39
Guided Assembly	40
Speech Synthesis Voice Fonts	40
Accessories	
Controls, Switches	41
Cables, Headers, Sockets, Pins.....	41
Header Isolator™ Protective Adapters	43
Probes	43
Power Modules	44
Tilt Stand, Labels	44
Storage, Transportation	45
Service	
Product Support Subscription, Calibration, Software Upgrade, Hardware Upgrade	46-47
CableEye Automation	
Macros and JavaScript® Scripts, Relay Boards	48



HiPot Systems, p.10

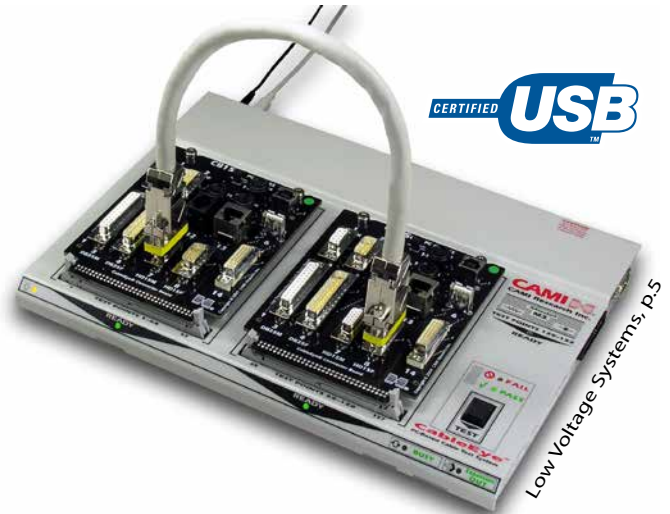

Guided Assembly, p.40



CB19 Board, p.18



CAMI Research Inc.

Tel: +1 978-266-2655

42 Nagog Park, Suite 115, Acton, MA 01720

THE CABLEEYE TESTER



Test with confidence, test with CableEye testers!

A leader in the development of PC-based Cable and Harness testers for over twenty-five years, CAMI offers the **CableEye®** suite of low and high voltage products (shown left and below respectively).

Expandable and programmable, these Future-Ready testers provide pass/fail check and diagnostics for countless applications in Transportation, Energy, Medical Devices, Defense, Scientific R&D, Telecom, and more.

- Easily test ANY cable with ANY connector.
- Setup of these USB Plug-and-Play testers is a breeze.
- Pass / Fail indicators + Digital I/O's.
- Special plug-in boards available to mount harness adapter cables.
- Self-check on start up confirms operability.



- Industry-standard 64-pin dual-row header connector interface.
- Use our **Header Isolator™** protective adapters to protect dual-row headers from normal wear-out.

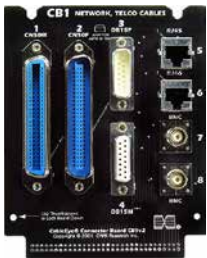

- Many standard plug-in connector boards and test fixtures available.
- Automatically identify connectors.
- Use our blank connector boards to mount unusual connectors.
- Design your own custom boards.

- Test simple two-ended cables or complex harnesses with ease.
- Vertically-stacked expansion modules add 128 test points each.
- Special fixtures available that easily link testers to harness boards.
- Reuse your existing test fixtures from other brands — CAMI will adapt them.

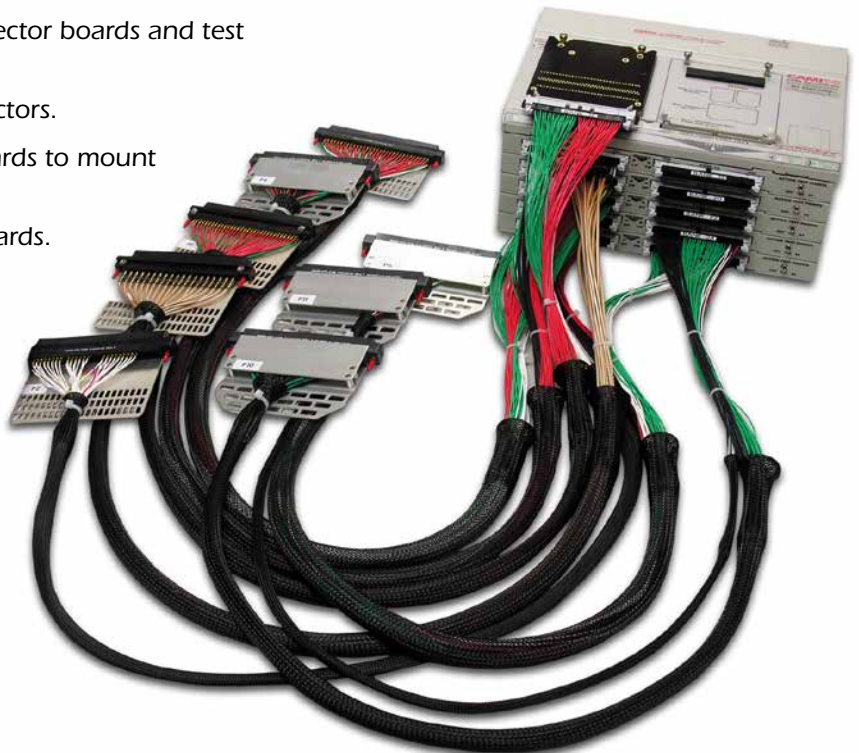

THE CABLEEYE SOFTWARE

Find defective, miswired, and intermittent cables instantly.

All testers ship with a comprehensive software package that provides test functions, connectors database, graphic wiring display, reporting, data logging, automation scripting and many more features.

- Optional software for custom interfacing, custom connectors graphics, import/export, and guided assembly.
- One common software platform for ALL **CableEye** testers. New software releases, backward compatible with every USB tester we've ever made.
- Select your screen navigation language from CHN, DEU, ENG, ESP, FRA, HEB, ITA, JPN, KOR, POL, TUR, and UKR and add notes in any language.
- Robust - Versatile - Easy to Upgrade.
- **Windows**-Based, compatible with Desktop PCs, Laptops, Touchscreen and Tablets.

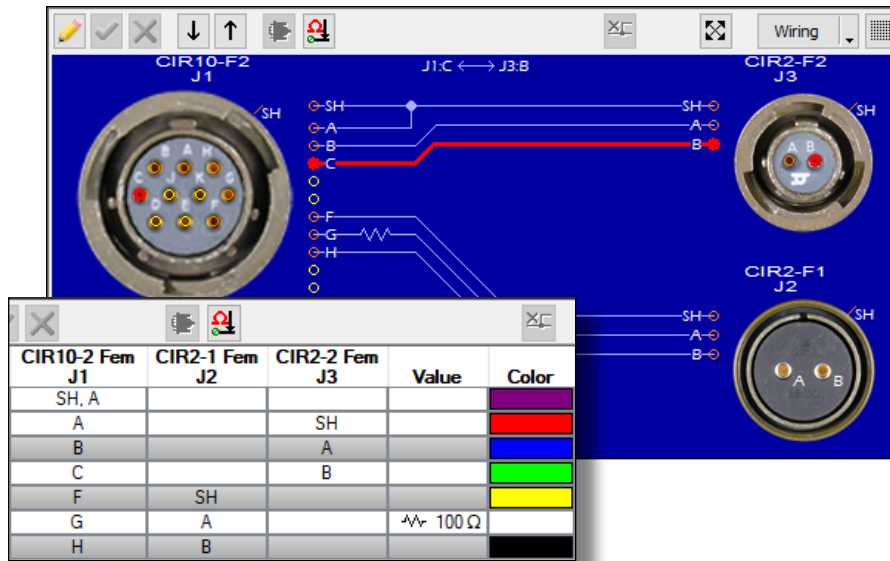

- Superb color-coded graphic-rich display provides clarity and, at the click of a button, visualize the wiring schematically or as netlist.
- Easily determine type of error and locate it immediately.

- Amazing out of the box color reports and labels, with PASS/FAIL indicators, graphics and netlist.
- Custom reporting software.
- Print directly to any **Windows**-compatible standard or label printer.

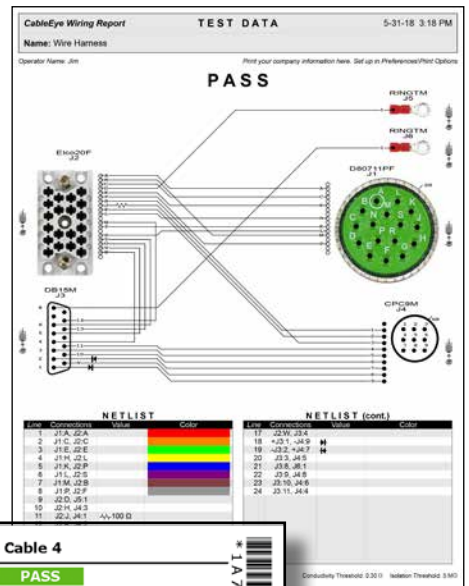

Automation-Ready Testers

- One button operation or hands-free fully automated control.
- Custom data input, using keyboard or bar code scanner.
- Control external devices with ease.
- Protect your data against unauthorized changes.
- Integrate with automation systems using our API **.NET** and **LabVIEW** Programming Interfaces, p.39.



CABLEEYE SYSTEM SELECTION GUIDE

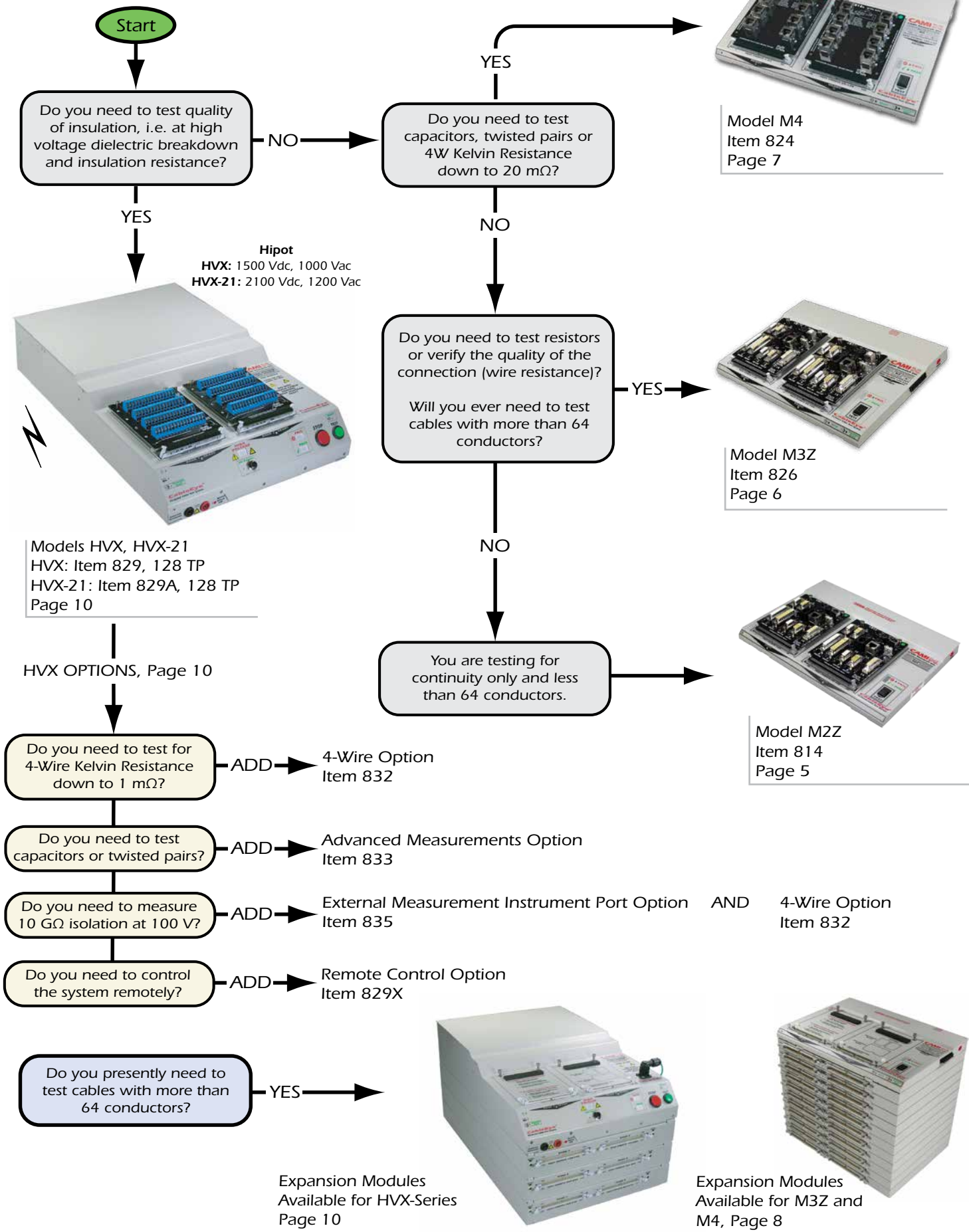

M2 SERIES SYSTEMS

(Low Voltage)



Item 814, CableEye M2Z

This tester provides basic continuity measurement in cables and small wire harnesses. It is suitable for cables carrying digital signals or any electronic signaling where small amounts of resistance in the cable or connections will not affect the function of equipment to which the cables are connected. The tester includes a 128-point fixture, a probe port, and electronics permitting it to test cables with a maximum of 64 conductors. The price includes a probe, board set, and items as listed under "Included with All Testers" (p.6). Use the TEST button on the tester or click on the software screen to trigger a test. A READY indicator confirms a link to the PC software, and PASS, and FAIL indicators visually show the test result. Measurement for a typical cable completes in less than a second. We use industry-standard 64-pin dual-row latch headers as an interface to all of our plug-in connector boards and external test fixtures. The aluminum case is formed from 1/16"-thick aluminum with scratch-proof Lexan surface for long life in an industrial environment. Calibration is not required. This model is not expandable. USB interface. *Ready to use.*

Item 810U, CableEye M2U-Basic

This model is no longer in production (superseded by the M2Z above). We will offer service until at least May, 2027, as long as components remain available. This includes Product Support Subscription and repair. Software updates and software upgrades will continue to be available well beyond 2027.

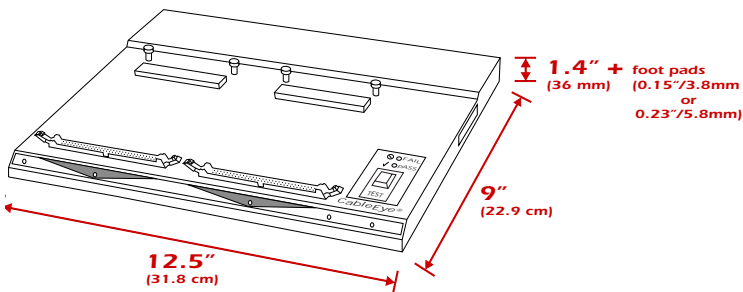

Dimensions for low voltage testers.

"... a Vital Tool for our Company"

The **CableEye** product has been a vital tool for our company since it has been deployed. Prior to using the **CableEye** system, we would validate harnesses and test connector products by using a multimeter or a tone box. This is a slow process and could take up to 30 minutes or more just for one harness or connector. In addition, the products were checked by two departments to validate continuity. With the **CableEye** tester, this has been reduced to a couple of minutes with the longest part of the test being the connecting of the cable to the tester. Additionally, the process of having two departments validate the product has been reduced to one department. This saves manpower and hours that can be reallocated to other tasks. Thank you for a wonderful product and support.

M.H. - Test Products Incorporated

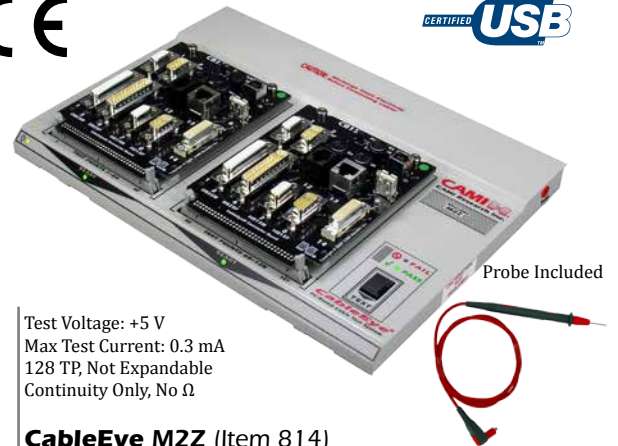

Test Voltage: +5 V
Max Test Current: 0.3 mA
128 TP, Not Expandable
Continuity Only, No Ω

CableEye M2Z (Item 814)
shown with CB15C Boards (Item 745C) Installed

M2Z — Final Check

Choose any of our other series models if you will ever need more than 128 TPs or to measure the quality of the connection in your cable/harness. M2 series testers do not measure wire resistance so can not check connection quality.

TIP: We recommend the M3Z or M4 for your back-plane and complex network applications.

Operating Software

All testers ship with comprehensive software providing test functions, connector database, graphic wiring display, reporting, data logging, automation scripting and many more features.

camiresearch.com/software

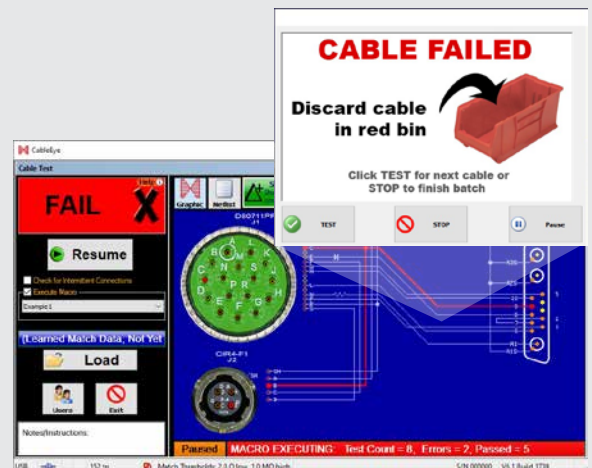

TIP: Run Automatic Data Logging, Batch Recording, and Display Digital Work Instructions

M3 SERIES SYSTEMS

(Low Voltage)



Item 826, CableEye M3Z (0.1 Ω – 5 MΩ)

Replacing the discontinued M3U/M3UH, the model M3Z differs from the M2Z in that the M3Z employs a different electronic design and is expandable. This allows measurement of resistance (and thus the quality of connections), diodes, and other measurement functions including for complex network and backplane applications.

The M3Z determines connectivity in cables and wire harnesses, but also allows you to set thresholds for maximum permissible connection resistance, and minimum isolation resistance between unconnected wires. For connection resistance, set the low threshold to as little as 0.1 Ω, and for isolation resistance, set the high threshold as high as 5 MΩ. Typical thresholds for general-purpose testing would be 5 Ω maximum for connection resistance, and 1 MΩ minimum for isolation. Settable resistance thresholds allow you to check for cold solder joints, certain types of crimp defects, improperly-seated connector pins, and intermittent connections.

Use the software to select one particular wire connection in a cable and make continuous resistance measurements at up to 10 cycles per second on that conductor while you flex the cable to look for bad connections. The entire cable may be scanned for intermittent connections at a faster cycle rate if you wish to do a general test for bad connections that may result from motion or flexing.

Measure embedded resistors from 100 Ω to 999 kΩ with 1% accuracy, and with less accuracy over the full range of 0.1 Ω to 5 MΩ. Measure diodes and resistor/diode combinations, and automatically learn networks of diodes and resistors for comparison against electronic modules with similar networks.

You may use the tester for Guided Assembly with our optional **AutoBuild™** software (Item 728, p.40). Operators will receive wire-by-wire assembly instructions to speed cable assembly and minimize errors, or connector pinning instructions with our optional **Light Director™** system (see p.34).

The M3Z controls the active test points through software, eliminating the toggle switch found on previous models. Expand the M3Z up to 2,560 test points by connecting expansion modules (Item 827, 128-points per module, p.8). Additional features include a remote control socket to be used for either an optional external footswitch (Item 714, p.41) or for a custom remote control to extend panel indicators, and an accessory socket for a probe or minihook connectors (Item 710, p.41). A probe comes with this tester and works with our software to identify unterminated wires. Use an optional wrist strap (Item 859, p.41) in place of the probe to identify wires with the touch of a finger. The price includes a board set, and items as listed under "Included with All Testers" on this page.

The tester comes calibrated with a Certificate of Calibration and measurement data. We recommend calibration yearly (see p.47). USB interface. *Ready to use.*



Test Voltage: +10 V
Max Test Current: 3.3 mA
Expandable to 2,560 TP
Continuity, Resistance 0.1 Ω to 5 MΩ

Probe Included

CableEye M3Z (Item 826)
shown with CB15C Boards (Item 745C) Installed

Included with All Testers

CB-T2 Board, **CableEye** Software, Power Module for LV Series, AC Plug for HVX Series, USB Cable (2 for HVX Series), Probe, Getting Started Guide, Software Introduction Booklet, User's Manual (PDF), and two-year Product Support Subscription (PSS). The subscription may be renewed yearly for continuing coverage, see p.46 for more information.



"Customer Support ... is Second to None"

*I want to thank everyone at CAMI for the tremendous support in getting us up and running with our new testers. I have been in the cable assembly contract business for over 30 years and the customer support level offered at CAMI is second to none. The product works as stated and the software is unbelievably easy to use. The conversion process from our old test system to the **CableEye** M3U Systems has progressed at a pace 4x faster than we had anticipated. A pleasure doing business with you guys and we hope to increase our line of CAMI testers in the near future."*

G.S. - Simco

Select Options | Low Voltage Testers

- Item 765, Relay Control Board for External Digital Control **P.27**
- Item 879, Environmental Sensor **P.41**
- Item 704G/H/K, Pelican Carrying/Storage Case **P.11**
- Item 755A, 778A/B, **Header Isolator™** Protective Adapters ... **P.43**
- Item 707, 708, 709, 728, 729, 730, 860, 861, Optional S/W **P.36**

M4 SERIES SYSTEMS

(Low Voltage)



Item 824, CableEye M4 (0.02 Ω – 6 MΩ)

Model M4 has all of the features of our Model M3Z. It uses the same aluminum case and software, but employs a different electronic design capable of measuring resistance more accurately than the M3Z.

Check discrete capacitors in the range of 50 pF to 100 μF, including polarized capacitors, with an accuracy of 5%. Measure multiple capacitors or capacitor matrices in one test cycle at the rate of approximately 20 capacitors per second (rate dependent on capacitance value).

Detect twisted-pair wires. The increased capacitance between twisted wires permits pairs to be distinguished from their untwisted neighbors. Cables may be scanned to reveal the location of twisted pairs, if any, and this learned data used to compare against untested cables.

By first measuring the capacitance of a known length of cable to determine its capacitance per foot (meter), we can use this figure to estimate the length of a longer cable, or to find the distance to a break in one conductor of a longer cable to within 3 feet.

Eliminate the fixture resistance of a long adapter cable using 4-wire Kelvin measurement with +/- 0.02 Ω resolution. This function requires a special test fixture (adapter cable or hard-wired interface) in which two test points, one for Source Current and one for Sense Voltage, are wired to each pin on the mating connector. The 4-wire function may also be used in a rapid cycle mode for intermittent connection testing.

Measure embedded resistors from 0.02 Ω to 9.99 Ω with an accuracy of +/- 0.02 Ω, within 1% from 10Ω to 999KΩ, and with increasingly less accuracy from 1 MΩ to 6 MΩ. Measure diodes, LEDs, and Zener Diodes (<10V).

In addition to the electrical test functions provided by the M4, you may use the tester for Guided Assembly with our optional **AutoBuild™** software (Item 728, p.40). Operators will receive wire-by-wire assembly instructions to speed cable assembly and minimize errors, or connector pinning instructions with our optional **Light Director™** system (see p.34).

The M4 controls the active test points through software. Expand the M4 up to 2,560 test points by connecting expansion modules (Item 825, 128-points per module - p.8). Additional features include a remote control socket, to be used for either an optional external footswitch (Item 714, p.41) or for a custom remote control to extend panel indicators, and an accessory socket for a probe or minihook connectors. A probe comes with this tester and works with our software to identify unterminated wires. The price includes a board set, and items as listed under "Included with All Testers" on this page.

The tester comes calibrated with a Certificate of Calibration and measurement data. We recommend calibration yearly (see p.47). USB interface. *Ready to use.*



Test Voltage: +10 V (adjustable)
 Max Test Current: 3.3 mA
 Expandable to 2,560 TP
 Continuity, Resistance 0.02 Ω to 6 MΩ

Probe Included

CableEye M4 (Item 824)
 shown with CB18A Boards (Item 748A) Installed

Line	RJ-8P Male RJ45M-1	RJ-8P Male RJ45M-2	Value	Pair	Twist	Color
1	1	1	↔ 0.04 Ω	1	160 pF	Orange/White
2	2	2	↔ 0.05 Ω	1	160 pF	Green/White
3	3	3	↔ 0.04 Ω	2	182 pF	Blue/White
4	4	4	↔ 0.05 Ω	3	171 pF	Orange/White
5	5	5	↔ 0.05 Ω	3	171 pF	Green/White
6	6	6	↔ 0.05 Ω	2	182 pF	Blue/White
7	7	7	↔ 0.04 Ω	4	162 pF	Orange/White
8	8	8	↔ 0.05 Ω	4	162 pF	Green/White

The **CableEye** Software reports Twisting Pairing and Wire Resistance results measured by the M4 tester.

"... nothing but positive reviews from our Quality department and more importantly from our customers."

We have used our CAMI CableEye test equipment for over three years. We routinely use it to test over 1,000 test points on an aviation harness and have nothing but positive reviews from our Quality department and more importantly from our customers. The reliability of the equipment allows us to provide our customers with the best possible products. We've also found that the customer service and response time from CAMI Research to be excellent. All in all a company I would highly recommend using.

Eric Lutz, VP Production - Galaxy Wire and Cable, Inc.

EXPANSION MODULES (Low Voltage)

Item 827, **CableEye M3Z-AEX Expansion Module**

Item 825, **CableEye M4-AEX Expansion Module**

Each module adds 128 test points and permanently attaches to the bottom of the control module leaving the bench footprint no larger than the control module alone. Stack the attached expansion modules vertically until the desired number of test points is achieved, up to a maximum of 2,560 test points (consisting of one control module and nineteen stacked expansion modules). Our software recognizes the additional test points automatically. All standard software functions scale up to work with the additional test points. Scanning time increases as more modules are added. The number of active test points is selected in the software.

Two 64-pin latch headers provide 128 test points per module. Unlike the control module, these 64-pin headers exit the case with pins parallel to the table top. Use a 64-conductor flat cable with wiremount socket to extend the test points to your custom test fixture or harness board. See Items 850-855 for custom flat cable and connectors (p.41-p.42).

Units require factory recalibration when an expansion module is added. The recalibration cost is included in the price of any new expansion module.

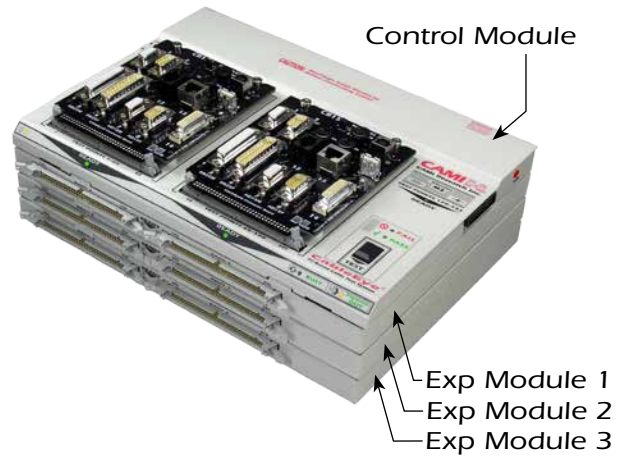

M3Z and M4
128 Test Points per Module
Expandable to 2560 TP

Attached Expansion Module
M3Z (Item 827) or M4 (Item 825)
with CB15C Boards (Item 745C) Installed
512-Point M3Z System Shown

How many test points do you need?
A test point is a connection point for one pin of one connector. To determine the number of points you need, consider the largest cable or harness you expect to test, and add up all the pins on all the connectors, including shields. Example: for an 8-wire shielded ethernet cable, you would need 18 test points.

“Your company’s fast response ... sets you apart from other diagnostic companies I deal with.”

I know that this new machine will find weaknesses in the slipring design. I love it. Now I can see where the nets are higher than acceptable continuity values. This is a good thing, since these are from customer returns that are greater than 7 years old. We need to know if they are close to catastrophic failure. This is going to improve our overall customer return quality.

Love this machine!

Your company’s fast response to our emails, and subsequent solutions with our CableEye challenges sets you apart from other diagnostic companies I deal with.

The “Can-Do” attitude is quite refreshing.

D. Reynolds - PVP Advanced EO Systems, Inc



M3Z and M4
128 Test Points per Module
Expandable to 2560 TP

Attached Expansion Module
M3Z, Item 827
No Connector Boards Installed
1,536-Point M3Z System Shown

QUICKMOUNT™ SYSTEM

Because attached expansion modules stack vertically, only two CB boards may be accommodated (mounted on the control module) regardless of how many attached expansion modules are connected. If you need to mount more than two CB boards to a system with vertically stacked expansion modules, use our separate **QuickMount™** housing, Item 712H, described below.

Item 712H, **QuickMount™** Housing for CB Boards

This free-standing, quick-release board fixture supports all CAMI CB connector boards. Use for connecting CB boards to an expansion module, or for applications in which the CB boards must be separated from the tester. Boards may be locked in place using supplied nylon thumbscrews. Add CB Board Ribbon Cables of any length to extend the housing away from the tester. For systems larger than 256 test points, use multiple **QuickMount** housings with increasingly longer expansion cables (we will build to order); refer to the photo below right. Requires two expansion cables. Two 3" ribbon cables, item 854X (p.42) are included. For high accuracy resistance measurements or High Voltage applications, we recommend item 864 (p.42), not included at this price. Rated to 2100 Vdc/1500 Vac.

Item 712A, Tilt Stand for **QuickMount™** Housing.....

Two aluminum brackets with rubber feet attach to the back of the **QuickMount** housing using supplied 4-40 screws and lockwashers. Once attached, these brackets tilt the unit forward at a 30° angle. Additional holes on the bottom of each bracket permit the entire assembly to be secured to a table top. Recommended for high-volume production or when using our **Light Director™** connector assembly system (p.34). Control Module Tilt Stands are also available (Item 857, p.44).



QuickMount Housing (Item 712H)
CB15C connector boards (not included)
shown mounted to illustrate function.

1536 TP system below uses 11
QuickMount Housings to provide 22
board positions in addition to the 2 on
the Control Module.

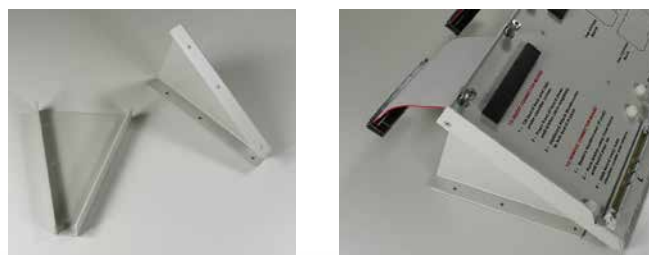

QuickMount™ Tilt Stand Brackets (Item 712A)

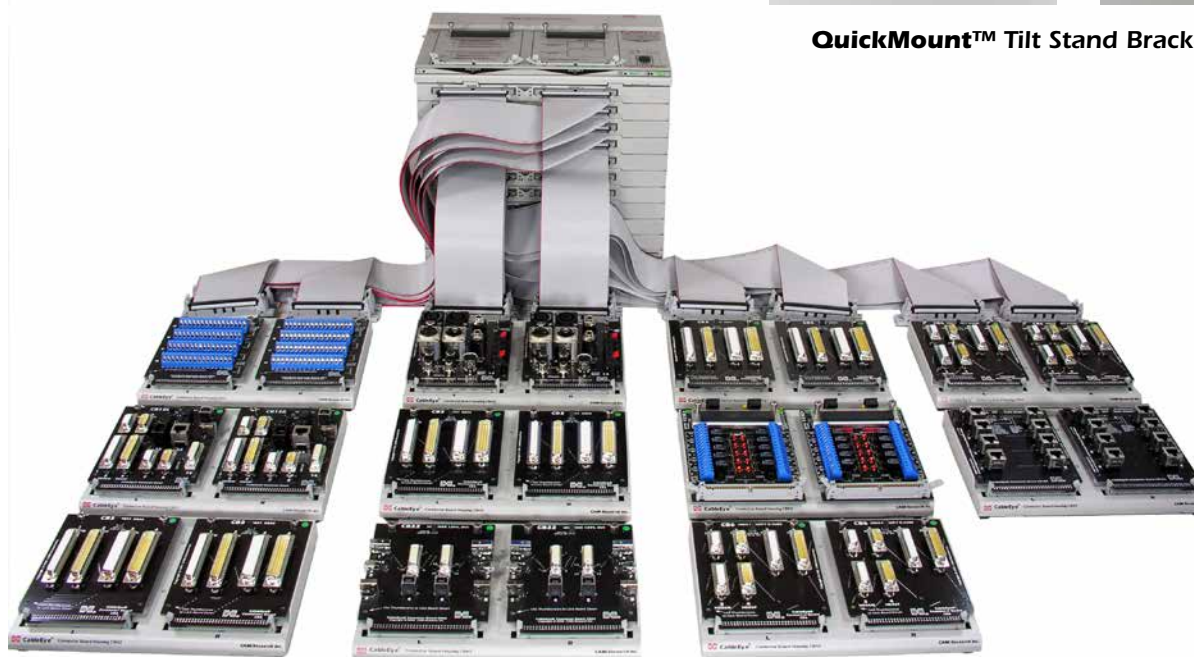

HVX SERIES SYSTEMS (High Voltage)

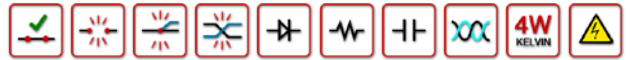

Special Offer: Buy HVX + Case, get 20% off 1st calibration service. Exp. 13m after purchase.

- Item 829, CableEye HVX High Voltage Test System
1500 Vdc, 1000 Vac Max
- Item 829A, CableEye HVX-21 High Voltage Test System
2100 Vdc, 1200 Vac Max

Options for Items 829 and 829A:

Contact us for prices if more than 384 TP are required.

- Item 828, HVX 128-point Expansion Module
Attaches to Base of Item 829. Max 1024 TP.
- Item 828A, HVX-21 128-point Expansion Module
Attaches to Base of Item 829A. Max 1024 TP.
- Item 828R, Retrofit Fee per HVX Series Expansion Module.....
- Item 832, 4-Wire Kelvin Resistance Measurement.....
1 mΩ to 15 Ω, Programmable. Test Current, 1000 mA Max
- Item 832R, 4-Wire Kelvin Retrofit Fee.....
- Item 833, Advanced Measurements Option
Capacitors, Wire Pair Capacitance, Twisted-Pair Detection,
Cable Length Check, 20 mΩ 2-Wire Resistance Resolution
Must be ordered at time of purchase of the control module.
- Item 829X, HV Remote Control Connector Option.....
Use for Deadman Switch or for External Control Panel
- Item 829XR, Remote Control Option Retrofit Fee.....
- Item 835, External Measurement Instrument Port Option.....
Measure 10GΩ isolation at 100V. Requires 4-Wire Option and
third party source meter (Keithley Model 2410)
- Item 835R, Ext. Meas. Inst. Port Option Retrofit Fee.....
- Item 765, Relay Control Board for External Digital Control..... **p.27**
- Item 879, Environmental Sensor **p.41**
- Item 704C/D/H/K, Pelican Carrying/Storage Case **p.11**
- Item 755A, 778A/B, **Header Isolator™** Protective Adapters... **p.43**
- Item 877, Protective Cover..... **p.45**
- Item 707, 708, 709, 728, 729, 730, 860, 861, Optional S/W **p.36**

Includes 128-point fixture, electronics, and software. Expandable to 1024 test points by connecting HVX Expansion Modules (Item 828 or 828A). Low voltage circuitry performs basic continuity and resistance checks typically in less than 0.5 s. Set resistance thresholds for contact resistance down to 0.1 Ω, and for low voltage isolation up to 5 MΩ. Measure embedded resistors from 100 Ω to 1 MΩ with 1% accuracy, and lesser accuracy from 0.1 Ω to 5 MΩ. Provides measurement of backplanes and complex networks. Four-wire Kelvin measurement option available for resistance measurement to 1 mΩ at up to 1000 mA test current. Measure diodes and diode forward voltage. The high voltage test phase permits expanded testing for insulation resistance and dielectric breakdown. After checking for opens, shorts, miswires, and resistance limits, the HVX system will apply a user-selectable voltage from 10 V to 1500 Vdc, or 10 V to 1000 Vac RMS (Item 829), or 10 V to 2100 Vdc, or 10 V to 1200 Vac RMS (Item 829A), to each connection group in the cable. Ramp rates and dwell time are adjustable. Current leakage detected during the HV test phase provides a measure of insulation resistance up to 1 GΩ (Item 829) or 5 GΩ (Item 829A), and any leakage current exceeding a preset limit reveals the presence of moisture, flux, or other contamination on exposed contacts.

Produces archival-quality reports for each cable tested showing the test voltage, leakage current, and insulation resistance for each wire group, and clearly denotes PASS or FAIL at the top of the report.

Robust hardware includes: A TEST pushbutton with READY, PASS, and FAIL indicators for one-button operation; signal remote control socket for an external footswitch (Item 714) or for a custom remote control



Hipot

HVX System
128 TP Shown
Expandable to 1024 TP

CableEye HVX System (Item 829)
shown with CB29 Boards (Item 759) Installed



External Terminals
for Single Channel
Safety Tests on Chassis,
Panels,
Components etc.



Item 829X
Optional HV Remote Control
Connector for Dead-Man
Switch
Adjustable Exit Direction
(includes connector, wired plugs
and instructions)

Connect CB Boards
or Flat Cable

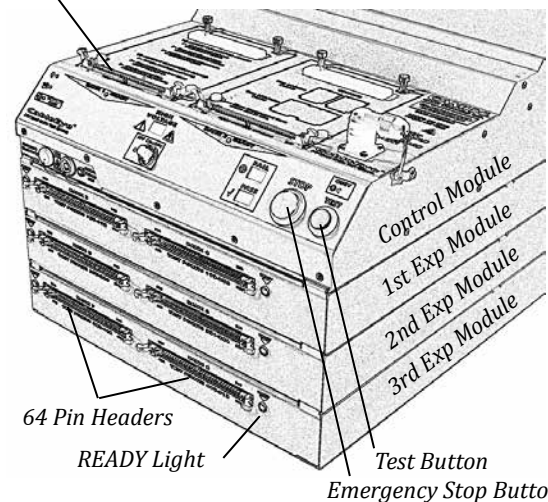

HVX System with Three Expansion Modules

to extend panel indicators; test probe socket; external terminals for insulation testing on chassis, panels and individual components; industry-standard 64-pin dual row latch headers for easy interface to external test fixtures of your own design; USB communications; and a rugged, 1/16" thick aluminum case with scratch-proof Lexan surface for long life in an industrial environment.

Standard operating software includes simple scripting capability for fully-automating production testing from test through reports and labelling: Set up pop-up Work Instructions. Program optional external relay boards to switch diverter gates, lock and release latches, and more. Program READY, PASS and FAIL signals to operate tower lights, LEDs, audible tones, label printers etc. Use optional API and Labview interfaces for integration with other equipment. Guided assembly and other software options available.

The price includes a board set, and items as listed under "Included with All Testers" on p6. *Ready to use.* Three expansion modules added to a control module provide a total of 512 test points in the system shown at the right. Another expansion stack of 512 points may be combined with this unit to provide a total of 1024 test points.

Plug in connector boards on the top of the unit to test small cables, or attach 64-conductor flat cables to the 64-pin test point headers. We have applications engineers available to advise customers on any type of custom electrical interface that may be required.

Advanced Measurements Option: Provides increased (x5) 2-wire resistance resolution, and measurement of capacitors, wire pair capacitance, twisted pair testing, and cable length (see p.13).

HV Remote Control Option (black connector on top): Along with the remote output available on the back of the unit, makes available all necessary control signals for an external User-designed control panel. Allows tester to be fully enclosed behind a connector rack or in a specially-designed case. Includes pre-wired plugs for HV remote and LV controls with wiring diagram and instructions.

External Measurement Instrument Port Option: comprises custom software and a hardware upgrade that allows an external measurement instrument to be used in combination with the HVX's

CARRYING CASES

- Item 704C, Rolling Pelican™ Carrying Case.....p.45**
- Item 704D, 704G, Rolling Pelican™ Carrying Case.....p.45**
- Item 704H, Pelican™ Carrying Case.....p.45**
- Item 704K, Rolling Pelican™ Carrying Case.....p.45**

- C:** For any HV tester with up to 1 expansion module.
- D:** For any HV tester with 2 or 3 expansion modules.
- G:** For any LV series tester with 4 or more expansion modules; highly recommended for 7 or more expansion modules.
- H:** For any LV series tester with up to 1 expansion module.
- K:** For any LV series tester with 2 or 3 expansion modules.

Transport or store your tester in a rugged watertight, dustproof, corrosion proof, foam-lined case. Large, safe-release latches make the case easy to open and yet secure from accidental release during transportation. Use the handles on the top or side for hand-carrying, or the extendable handle and wheels for easy rolling on smooth surfaces. Two padlock holes are available for extra security during shipment or while being stored.

Injection-molded case made of HPX high performance resin is virtually unbreakable, dent-resistant and shatter-resistant.



HVX System
512 TP Shown
Expandable to 1024 TP

CableEye HVX System (Item 829 or 829A) with Three Expansion Modules (Item 828) and Remote Control Option (Item 829X)

internal relay-switching matrix and reporting software. It uses the built-in external terminals of an HVX series tester to accept stimulus signals from the external source, and that source's USB or Serial channel to control it and read measurement data. co-requires the 4-Wire Kelvin Resistance Measurement option (Item 832), and a third party source meter (Keithley Model 2410).

A620 Standard

All HVX models permit cable and wire harness testing against the A620 industry-standard across all classes for Continuity, Shorts, Dielectric Withstanding Voltage, and Insulation Resistance.

Permanently attached Vortex valve automatically adjusts air pressure without letting in water, and won't unscrew from the case. Press & Pull latches open with the push of a button, yet stay closed securely under impact or stress. *Lifetime Manufacturer's Warranty*

See p.45 for more options and further details.



HVX TEST REPORT EXAMPLES

Video Screen Report

The screenshot shows the HVX test software interface. At the top, there are several status indicators: "4-Wire HV Enabled", "Max DC Voltage 500 vDC", "Max AC Voltage 500 vAC", and "Max Current 300 µA". Other parameters include "Ramp Up 5000 V/s", "Trip Delay 200 ms", "Dwell 200 ms", "Insulation Res 22 MΩ", "Ramp Down 5000 V/s", and "AC Test Freq 60 Hz". A "Settings" menu is visible in the top right.

The main area displays "Test Data" with a wiring diagram for "OBD_II F B1" and "OBD_II M B1". A red wire is highlighted in the diagram, and the corresponding pins in the connector graphics are also highlighted. A green checkmark is visible in the bottom right of the test data area.

Click wire to highlight. Pins in connector graphic corresponding to highlighted wire also highlight.

Example Print Report

The printed report includes the following sections:

- CableEye Wiring Report**: TEST DATA, 12-27-13 4:28 PM, 15 Wire Shielded Complex, Test Technician: David B., CAMI Research Test Lab.
- PASS**: Large green text indicating the test result.
- Wiring Diagram**: Shows the connection between OBD_II F B1 and OBD_II M B1.
- HIPOT PARAMETERS**:

Low Voltage Tests	Low Threshold 1.0 Ω	High Thresh 3 MΩ
High Voltage Tests	DC Max Voltage 500 vDC	Max Current 200 µA
	AC Max Voltage 500 vAC	Insulation Res 22 MΩ
	Dwell Time 200 ms	Max Current 300 µA
		Insulation Res 1.0 MΩ
		Ramp Up 5000 V/s
		Ramp Down 5000 V/s
- NETLIST**:

Line	ID_II Fern	BD_II Ma	Value	HiPot	DC Curr	DC MaxV	DC Iso	AC Curr	AC MaxV	AC Iso
1	SH, 4	B1	↔ 0.9 Ω	✔	< 1 µA	501 V	> 1 GΩ	0.278 mA	502 V	2 MΩ
2	1	1	↔ 0.2 Ω	✔	< 1 µA	500 V	> 1 GΩ	0.077 mA	505 V	7 MΩ
3	2	2	↔ 0.1 Ω	✔	< 1 µA	500 V	> 1 GΩ	0.074 mA	505 V	7 MΩ
4	3	3	↔ 0.2 Ω	✔	< 1 µA	500 V	> 1 GΩ	0.081 mA	505 V	6 MΩ
5	4	4	↔ 0.4 Ω	✔	< 1 µA	501 V	> 1 GΩ	0.278 mA	502 V	2 MΩ
6	5	5	↔ 0.1 Ω	✔	< 1 µA	500 V	> 1 GΩ	0.079 mA	504 V	6 MΩ
7	6	6	↔ 0.1 Ω	✔	< 1 µA	500 V	> 1 GΩ	0.070 mA	506 V	7 MΩ
8	7	7	↔ 0.1 Ω	✔	< 1 µA	500 V	> 1 GΩ	0.082 mA	504 V	6 MΩ
9	8	8	↔ 0.1 Ω	✔	< 1 µA	500 V	> 1 GΩ	0.077 mA	504 V	7 MΩ
10	9	9	↔ 0.1 Ω	✔	< 1 µA	500 V	> 1 GΩ	0.081 mA	505 V	6 MΩ
11	10	10	↔ 0.1 Ω	✔	< 1 µA	500 V	> 1 GΩ	0.070 mA	505 V	7 MΩ

External Terminals Control Screen

The screenshot shows the external terminals control screen. At the top, there are status indicators: "HV Enabled", "Max DC Voltage 1500 vDC", "Max AC Voltage 0 vAC", and "Max Current 700 µA". The "HiPot Test" section shows "Preset Selection" as "Standard Test" and "Test Parameters" including "Test B1 DC", "Dwell Time 2200", "Max Voltage 1500 V", "Trip Delay 20", "Max Current 700 µA", "Ramp Up 5000", "Insulation Res 150 M", and "Ramp Down 5000".

The "Test Results" section shows "Measured Voltage 1499 V", "Measured Current 7 µA", and "Resistance 208 MΩ". A "Keep Hands Clear!" warning is displayed. A graph shows the voltage ramping up to 1500 V over time.

4-Wire Test Result Screen

Line	HDR-B1	HDR-B4	Probe	Value	4-Wire Current	HiPot Enable
1	2	2		16 mΩ	1000 mA	✔
2	4	4		31 mΩ	1000 mA	✔
3	6	6		63 mΩ	1000 mA	✔
4	8	8		126 mΩ	1000 mA	✔
5	10	10		249 mΩ	1000 mA	✔

CE Compliance-Tested for Safety and Electromagnetic Compatibility

CableEye® TECHNICAL SPECIFICATIONS



	Low Voltage			Low and High Voltage	
	M2Z Item 814	M3Z Item 826	M4 Item 824	HVX Item 829	HVX-21 Item 829A
Control Module Test Points	128	128 + 24		128 + 24 for LV tests 128 for HV tests	
Max Test Points	128	2560 + 24		1024	
Test Time (128 Test Points) ¹ Continuity Only With Resistance Test	0.20 s N/A	0.15 s 0.40 s	0.15 s 0.40 s	Depends on voltage, ramp rate, test algorithm From 0.20 / 0.15 s From 0.25 / 0.40 s	
Resistance Thresholds	46 kΩ, Fixed	0.1 Ω to 5 MΩ	0.02 Ω to 6 MΩ	0.1 / 0.02 Ω to 1 GΩ	0.1 / 0.02 Ω to 5 GΩ
Resistance Accuracy: From 10Ω to 100Ω		±0.2 Ω	±0.15 Ω	±0.2 Ω / ±0.15 Ω	
From 100Ω to 1MΩ		1 %	1 %	1 %, 5 % from 1 MΩ to 100 MΩ	
Full range		Lesser accuracy over full range.		Lesser accuracy above 100 MΩ	
Resistance Range		0.1 Ω to 5 MΩ	0.02 Ω to 6 MΩ	0.1 / 0.02 Ω to 5 / 6 MΩ	
4-Wire Kelvin			20 mΩ ± 20 mΩ, From 20 mΩ to 15 Ω Test Current: 3.3 mA	1 mΩ ± 1 mΩ, From 1 mΩ to 15 Ω Test Current 100 mA to 1 A Optional Feature (Item 832) ■	
Intermittent Connection Scan Rate ¹	33 Scans/s	18 Scans/s - 128 TPs 47 Scans/s - 64 TPs		18 Scans/s - 128 TPs 47 Scans/s - 64 TPs	
Diode Measurement	Orientation Only	Orientation, Forward Voltage and Reverse Breakdown <10V		Orientation, Forward Voltage and Reverse Breakdown >10V	
Test Voltage	5V	10V	Adjustable: 1.7V, 2.5V, 3.3V, 5V, 10V	10 - 1500Vdc or 10 - 1000Vac _{rms} ^{1,2} in Increments of 1V	10 - 2100Vdc or 10 - 1200Vac _{rms} ^{1,2} in Increments of 1V
Test Voltage Accuracy				DC: ± 2%, ±1.5V AC: ±4%, ±2Vrms	
Max. Test Current	0.3 mA	3.3 mA		3.3 mA LV to 1 A with 4-Wire option	
Capacitance Range ¹				50 pF - 100 μF	
Capacitance Accuracy ¹				±5 %	
Capacitance Meas. Rate ¹				20 Measurements/Sec at 100 nF or less	
Twisted Pair Measurement ¹				Yes, 6 ft Minimum Length	
Meas. Cable Length ¹				Minimum Length 6 ft, ±3 ft	
Meas. Distance to Break ¹				Minimum Distance to Break 6 ft, ±3 ft	
Dwell Time Range		1 μs to 100 ms		LV: 1 μs to 100 ms HV: 30 ms - 300 s	
Insulation Resistance Measurement		5 MΩ at 10V	6 MΩ at 10V	2 MΩ - 1 GΩ at 1500Vdc 2 MΩ (min) at 1000Vac Current Sensitivity: 1 μA	2 MΩ - 5 GΩ at 2100Vdc 2 MΩ (min) at 1200Vac Current Sensitivity: 0.2 μA
Digital I/Os	Inputs Only	Pairs of Test Points used as Inputs, 50+ Relay Outputs with optional Relay Boards (Item 765) ■			
Calibration	Not Required	Recommended Yearly			
Test Point Connectors	64-pin dual-row headers, 0.1" (2.54 mm) centers. Two per 128-point module				
Remote Control Socket	No	Yes, MiniDIN8 Connector for use with e.g. Footswitch, External Control Panel			
Probe Socket	Yes. Probe included.	Yes. Probe included with tester. Accessory port also usable with minihook cables.			
Power Requirement	9Vdc at 300 mA (max) 3W, from wall module	18Vdc at 500 mA (max), 9W		100 - 250Vac, 50-60Hz 130W (max) for 128 TPs; 175W (max) for 512 TPs IEC-standard universal C14 chassis plug	
Weight Control Module, Expansion Module	2.48lb (1.12kg)	2.50lb (1.13kg) 1.58lb (3.48kg)	2.37lb (1.07kg) 1.58lb (3.48kg)	13.33lb (6.05kg) ³ 7.26lb (3.30kg) ⁴	13.74lb (6.23kg) ³ 7.26lb (3.30kg) ⁴
Computer Requirements	Any Windows-capable machine running Windows 7 or later. Compatible with touchscreen and laptop PCs.				
USB Interface	USB 1.1, Fast			USB 1.1, Fast, Two Ports	
Environmental Specs	Environmental, EMC, and Safety Specifications: camiresearch.com/environmental-specs.pdf				
Product Support	Product Support Subscription (Software Hardware Tech Support Warranty). Renewable yearly: camiresearch.com/advantage				

Values in blue text for HVX Advanced Measurement Option Installed (Item 833)

TEST AND MEASUREMENT MATRIX

	LV			HV
	M2Z	M3Z	M4	HVX Series
Continuity				
Opens, Shorts, Miswires	●	●	●	●
Intermittent Faults	●	●	●	●
Complex Networks, Backplanes		●	●	●
Resistance				
Connection, Non-Connection Quality		●	●	●
Resistance (2-Wire)		●	●	●
Continuous Resistance Scan		●	●	●
Fixture Resistance Nulling		●	●	●
Resistance (4-Wire Kelvin)			●	■
High Current Resistance				■
Capacitance				
Wire Length, Cable Length			●	■
Length to Fault (Open/Short)			●	■
Twist Pairing			●	■
Single Channel Safety Test				
Chassis, Panels, Transformers, etc.				●
Insulation Quality				
Dielectric Strength, Withstand Voltage				●
Insulation Resistance		●	●	●
Presence of Contaminants				●
In-Line Components				
Resistors		●	●	●
Diodes				
Orientation	●	●	●	●
Forward Voltage		●	●	●
LEDs				
Orientation	●	●	●	●
Color Detection		●	●	●
Zener Diodes				
Orientation	●	●	●	●
Forward Voltage		●	●	●
Reverse Breakdown Voltage <10V		●	●	●
Reverse Breakdown Voltage >10V			●	●
Capacitors			●	■
Environmental Data				
Temp, Rel-Humidity, Pressure Sensor	■	■	■	■

Key: ● Standard Feature
■ Optional Feature



Low Voltage Models



High Voltage Models

Automation-Ready Cable and Harness Testers
camiresearch.com/benefits

¹ Some values are dependent on the number of Expansion Modules. Contact us for details.
² Max. Vac reduced for HVX systems with TPs ≥ 640.
³ Options not included. ⁴ Plus 8.8lb for 512 TPs.

CONNECTOR BOARD INDEX

Connector Type	CB Board
Audio	CB19
Bare Wire Interface	CB27, 29 Series
Centronics	CB1, 17
Cinch Edgcard	CB39
Circular	CB8, 8H, 30, 30H
Cirris Adapter Boards	CB34
Coaxial: BNC, SMA, SMB, N	CB1, 16A
Compact Brute	CB30F
DIN Circular	CB15C, 19
Data Transfer	CB26G/S/M/V
Displayport	CB26K, 26T
Dsub	CB1, 3, 6, 7, 15C, 32, 47
Firewire	CB26D
Flat Cable IDC	CB2, 2A, 2B
Flat Cable HD IDC	CB12/A, 24,
Flat Cable 2 mm	CB13
HDMI	CB26E, 26T
Infiniband	CB26F
iPass	CB26H
LFH	CB14, 30C/D
Metral	CB31
Micro D	CB26L, 41, 42, 43, 44, 46
MICTOR	CB30A/E
Mini D	CB14, 21
MiniCentronics	CB20, 23
Mixed Coax/Signal	CB16
Nano D	CB41A, 42A
Power	CB9, 28, 30F, 33
Picoflex	CB54
Rack & Panel	CB11, 40
RJ Modular	CB1, 15C, 18/A/B/C, 26C
SCSI	CB1, 5, 20, 21, 23, 26S
Serial ATA	CB26D, I
Shielded Data Link	CB26G, S
SmartSerial	CB26A
Surface Mount	CB12A, 45, 49, 51, 55
USB	CB15C, 22, 26D/N/U
Utility Boards	CB25A, 29BB/HB, 35, 48A/B, 50A, 52, 53, 58, T2
v.35	CB8, 8H, 30, 30H
VHDCI	CB26B
VME	CB10
ZIF	CB30B/G

Boards highlighted in red are HV Rated above 500 V

CONNECTOR BOARD	PAGE
CB1, 2, 2A, 2B, 3, 5, 6, 7	14
CB8, 8H, 9, 10	15
CB11, 12, 12A, 13, 14, 15C	16
CB16A, 17, 18, 18A, 18B, 18C, 19	17
CB20, 21, 23, 24, 25A	18
CB25, 25X	19
CB26, 26A, B, C, D, E, F	20
CB26H, I, K, L, N, S, T, U, V	21
CB27, 28	22
CB29 series	23
CB30, 30H, 30A	24
CB30B, C, D, E, F, G	25
CB31, 32, 33, 34	26
CB35, 40	27
CB37A, 38A	34
CB41/A, 42/A, 43, 44, 45, 46, 47, 48	28
CB49, 51, 53, 54, 55, 56, 58	29
CB-T2, 50A, 52, 58	30
CB25A, 48A/B	43

Example Plug-In Board Configurations

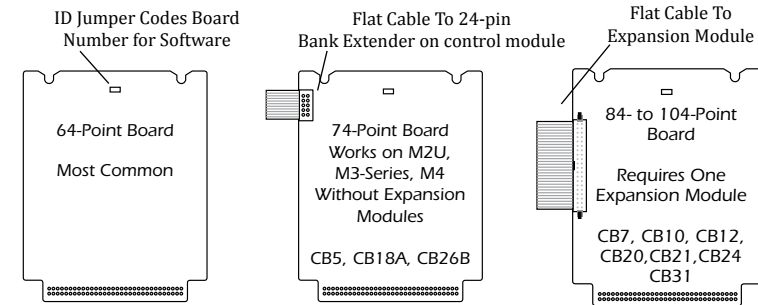
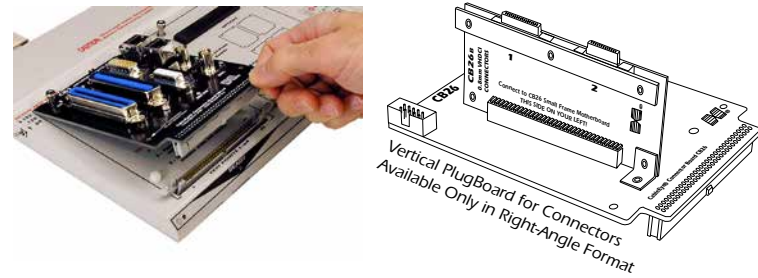

Auto ID

For pre-populated and pre-configured boards, the tester GUI automatically displays a graphic of the connectors (and wiring) under test.

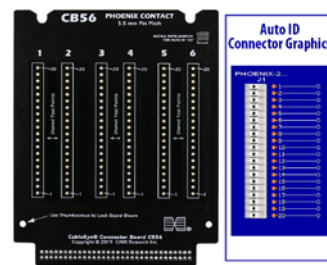

CB FEATURE KEY (pp. 14-29)

	Connectors Not Included: Solder ¹ Service, or Customization (Item 899C) Available
	Connectors Included: Unsoldered
	Expansion Module Required: Quantity Noted. Not Compatible with M2U-Basic/M2Z. (If Asterixed, See Image Notation for Special Conditions)
	Requires Software Build Version Noted or Newer to Enable Auto ID.
	Quantity of Boards Included. E ≡ Expander Cable Included.

1 SOLDER SERVICE: We mount connectors that you supply. Test is only possible, and included, if you are able to supply us with test cables. Test cables will be returned. When ordering connectors, choose post length suitable for 0.093" thick PCB - the thickness of all CAMI CB boards. Contact us for pricing.

2 EXPANSION MODULES: See pp. 8 and 10. Not Compatible with Model M2U-Basic/M2Z.

Links at camiresearch.com	
/catalog	Large Color Photos of All CB Boards
/board_finder	Find Boards by Connector Type
/cb-compatibility	Tester Configuration Requirement for Each Board

CONNECTOR BOARD SETS

Boards from different sets may be mixed to accommodate any combination of connectors. In most cases, you may connect a cable to only one connector at a time on each board.

Item 731, CB1 Connector Board Set for Telco and SCSI 50-pin, RJ44/45, DB15, and BNC Cables.....

Has connectors for Centronics 50-pin male and female (Telco 25-pair and SCSI-I cables), DB15 male and female (network and video cables), two shielded RJ44/45 modular connectors (8-position, 8-conductor network and telephone cables), and two coax BNC connectors (network and video cables).

Item 732, CB2 Connector Board Set for IDC Flat Cables, with Shrouded Latch Headers (large sizes)

For flat cables with IDC wiremount sockets. Board includes dual-row headers for 60, 50, 40, 34, and 26 pins (see Item 732A below for small header sizes). One 64-position footprint is open for a User-supplied custom size. Substitute bare headers (732B) or no headers (732BB) for shrouded latch headers on special order.

Item 732A, CB2A Connector Board Set for IDC Flat Cables, with Shrouded, Latch Headers (small sizes)

This board is identical to Item 732, but includes dual-row headers for 24, 20, 16, 14, and 10 pins. Other header sizes can be provided also; specify when ordering. One 64-position footprint is open for a User-supplied custom size. Substitute bare headers or no headers for shrouded latch headers on special order.

Item 733, CB3 Connector Board Set for DB37 and DB50 Cables.....

Has connectors for DB37 male and female (RS449), and DB50 male and female (digital control and communications cables). These and all other Dsub connectors we use are manufactured with machined pins (not stamped pins) for long life. **Rated to 1000 Vdc/750 Vac.**

Item 735, CB5 Connector Board Set for SCSI-I, -II and -III Cables.....

Has connectors for cables that have Centronics 50-pin male (SCSI-I), mini-Centronics 50-pin male (SCSI-I, -II), miniD 50-pin male (SCSI-I), and miniD 68-pin male (SCSI-II, -III) connectors. Use a gender changer for female cables. *Requires 152 test points; 68 pin connector not compatible with Model M2U-Basic/M2Z testers and requires expansion module with HVX series testers.*

Item 736, CB6 Connector Board Set for High-Density Dsub Cables.....

Has connectors for HD15 male and female (used on video boards and monitors), HD26 male and female (used in networks and high-speed communications), and HD44 male and female (used in communications and control applications).

Item 737, CB7 Connector Board Set for High-Density Dsub Cables.....

For HD62m,f and HD78m,f (used in digital control systems, factory automation and communications). *Requires 192 test points.*

Serial number of tester that will use the boards must be provided when ordering boards to ensure compatibility.

NOTE: Unless specified otherwise, CB boards on this page are rated for operation at 500 V dc/ac. CAMI boards can be factory certified for operation at the maximum board-rated voltage for a service fee (Item 626).

CB1
CN50, DB15
RJ45, BNC
(Item 731)

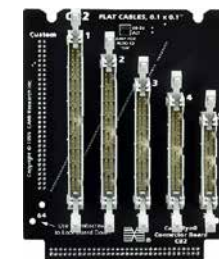

CB2 (Item 732)
Large and Small Dual-Row Headers for IDC Flat Cables



CB2A (Item 732A)

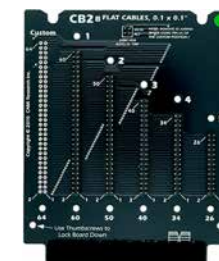

CB2B (Item 732B)
Bare Header Variant of CB2A

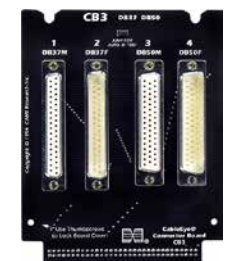

CB3
DB37, DB50
(Item 733)

CB5
CN50, MC50
MD50, MD68
(Item 735)

**Requires Expansion Module for HVX for 68 pin connector!*

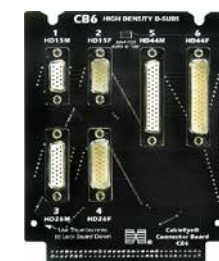

CB6
HD15, HD26, HD44
(Item 736)

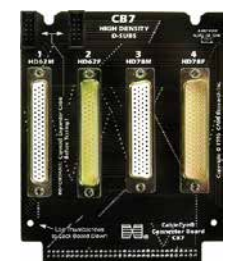

CB7
HD62, HD78
(Item 737)

Item 738, CB8 Connector Board Set for Circular Connectors and Custom Interfaces.....

 This generic board accepts a wide range of circular or other connectors, and accommodates panel- and/or cable-mounted mating connectors as well as LIF test blocks. Mount bulkhead connectors using the included kit of standoffs and screws. Any panel-mount circular connector with four mounting holes fits the "X"-pattern slots. Drill holes in the board to accommodate other mounting arrangements. Connector pins are wired to labeled pads surrounding the board. Connectors of up to 62 pins can be accommodated. Mount up to four small circular connectors (mounting hole spacing < 0.9"), or one large connector (mounting hole spacing < 2.3"). Bare area provided for custom labeling such as a bar code. When wiring is displayed, a generic dual-row header is shown, and a jumper setting on the board determines whether lettered or numbered pin labels are used. To display connectors realistically (recommended), map the fixture using the **PinMap™** fixture editor software. Use two CB8 boards together, or a CB8 in combination with any other CB board or built-in connector to accept any cable type. See CB30 p.24 for higher pin-capacity variant (128 pins). Customization service available.







**CB8 (L),
CB8H (R)**
Circular
Connectors
(generic)
(Items 738,
738H)



CB8/CB8H Standoff Kit

Item 738H, CB8H Connector Board Set for Circular Connectors and Custom Interfaces.....

 For operation beyond 1500V, certification fee required.
 A variant of the CB8. Customize with any number of connectors not exceeding a total of 64 pins. **Rated to 2100 Vdc/1200Vac.**



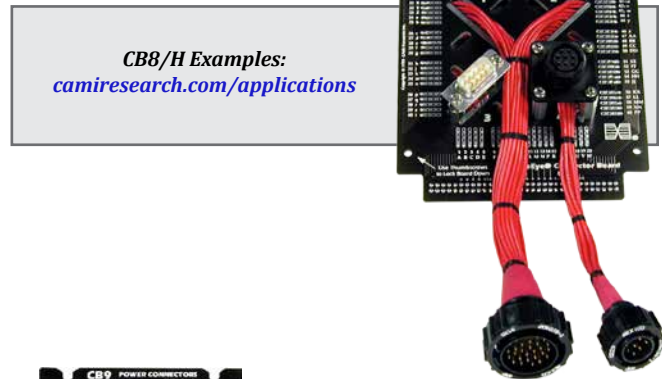

Item 739, CB9 Connector Board Set for Molex, Single-Row Headers, and Power Supply Connectors

 Includes connector positions for Molex strip headers and sockets (both 0.156" and 0.100" centers) up to 25 pins, AMP **MATE-N-LOK®** connectors (2-, 3-, and 4-pin male and female), AMP **MATE-N-LOK** Matrix connectors (male, up to 15-pin), and Molex **Mini-Fit™** (male, up to 10-pin). Because power connectors come in many different arrangements, we provide a standard set of connectors in a separate package, unsoldered, so you may configure the board to best suit your needs. For each board, the unmounted connector package includes a Molex 24-pin breakaway header strip (0.156" centers), a Molex 25-pin breakaway header strip (0.100" centers), a Molex 13-pin header socket (0.156" centers), a Molex 25-pin header socket (0.100" centers), and **MATE-N-LOK** male 2-, 3-, and 4-pin headers (for female cables). Matrix connectors are *not* included in the kit. Software for connector graphics self-adjusts to measured wiring.



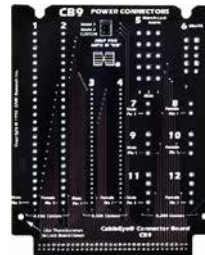

CB9
Power Connectors
(Item 739)



CB9 Connector Kit

Item 740, CB10 Connector Board Set for 64- and 96-Pin VME Cables

 Has positions for two DIN-standard VME connectors (0.1 x 0.1" centers). Both positions left open for User installation of desired connectors. Footprint consists of three columns of 32 pins each with 0.1" (2.54mm) pin grid spacing, 0.032" (0.081mm) hole dia. Requires 192 test points to test 96-conductor cables.



CB10
VME Connectors
(Item 740)

***Requires
Expansion
Module Only
When Pin-
count>64!**



NOTE: Unless specified otherwise, CB boards on this page are rated for operation at 500 V dc/ac. CAMI boards can be factory certified for operation at the maximum board-rated voltage for a service fee.

Item 741, CB11 Connector Board Set for Elco 90- and 120-pin Rack & Panel Connector (used in Audio Patch Panels).....

 The one open connector position will accept either a 90- or 120-pin Elco/Edac Rack & Panel connector, either male or female. **[2E]**

CB11
Elco/Edac 90- and 120-Pin Connectors
(Item 741)

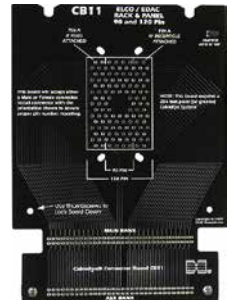

Item 742, CB12 Connector Board Set for High-Density IDC Flat Cables with Shrouded Latch Headers.....

 Test high-density flat cables with IDC wiremount sockets (0.025" wire centers, 0.050" x 0.100" pin centers). Three 80-pin positions are available on each board. Also use with standard AMP, 3M, or T&B connectors. Header sizes of 80, 68, 60, 50, 40, 34, 30, 26, and 20 pins. **[2E]**

CB12
High-Density Flat Cable Connectors
(Item 742)

****Requires Expansion Module Only When Pin-count >60!***

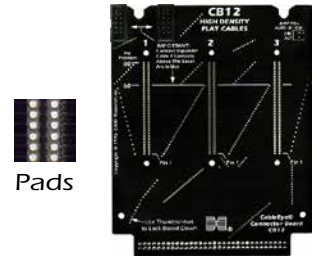

Item 742A, CB12A Connector Board Set for High-Density IDC Flat Cables with Shrouded Latch Headers.....

 Same as CB12 but with pin centers at 0.050" x 0.050". May also be used with surface-mount connectors having either 0.050" x 0.100" or 0.050" x 0.050" leg spacing. **[2]**

CB12A
High-Density Flat Cable Connectors
(Item 742A)

****Requires Expansion Module Only When Pin-count >60!***

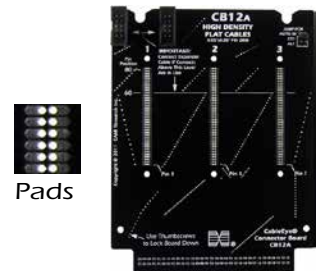

Item 743, CB13 Connector Board Set for 2 mm (0.079") Cables.....

 Connector positions for 2 mm single- or dual-row headers up to 60 pins. Six identical connector positions. Because 2mm connectors come in many different arrangements for both single- and dual-row, we provide a standard set of connectors in a separate package, unsoldered, so you may configure the board to best suit your needs. A single position will accept two headers, one top-justified and the other bottom-justified, if the combined length can be accommodated by the height of that position. Single-row headers may be mixed with double-row headers. For each board, the connector kit includes three 72-pin dual-row breakaway headers and three 36-pin single-row breakaway headers. Software for connector graphics self-adjusts to measured wiring. **[2]**

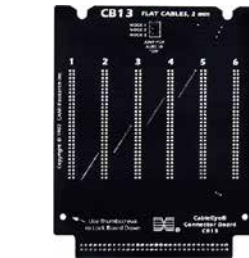

CB13 Connector Kit

Item 744, CB14 Connector Board Set for Molex 60-pin LFH™ Connectors, Male and Female, and 26-pin miniD Female Connector for Male cables.....

Configured for router cables used in network and telecom applications. Has male and female 60-pin Molex LFH™ connectors, and a female MD26 connector used for male cables. Note: See CB30C for LFH 160-Pin, and CB30D for LFH 200-Pin on p.25. **[2]**

CB13
2 mm Connectors
(Item 743)

CB14
Molex LFH Connectors
(Item 744)

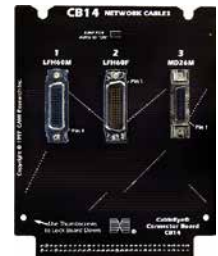

Item 745C, CB15C Connector Board Set for Common Computer and Peripheral Device Cables.....

Includes 14 standard connectors commonly found on computers and peripheral devices: DB9 male and female (serial port), DB25 male and female (serial port, printer port), high-density HD15 male and female (analog monitors), DVI female (digital monitors), USB-A and USB-B, miniDIN4, miniDIN6, and miniDIN8 (for male cable, used with older mice, keyboards, and printers), RJ12 (6-position 6-conductor, used with modem and telephone), RJ45 (8-position 8-conductor, used with ethernet cables). Mini-DIN sockets may be configured for 5- and 7-pin miniDIN sizes on special order. See CB22 (p.18) or CB26 (p.20) for additional USB, Firewire, and DVI connectors. **[2]**



CB15C
Computer Connectors
(Item 745C)

NOTE: Unless specified otherwise, CB boards on this page are rated for operation at 500 V dc/ac. CAMI boards can be factory certified for operation at the maximum board-rated voltage for a service fee.

Item 746A, CB16A Connector Board Set BNC, SMB, SMA, and N Connector Cables.....

Includes eight BNC connectors for coaxial cables, and *open footprints only* for SMB, SMA, and N connectors. SMB, SMA, and N connectors *are not included*. **ID** B1212 or later. **2**

CB16A
 Video Connectors
 (Item 746A)

*Note: SMB, SMA, and N connectors **not** included!
 Board footprints present.*

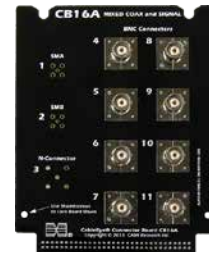

Item 747, CB17 Connector Board Set for Telecommunications Cables and IEEE 488 Cables.....

For AMP Champ connectors (full-size Centronics-style connectors) in 64-pin male and female (for Telco central office and other applications), 24-pin male and female (IEEE 488 and HP-IB instrument bus cables), and 14-pin male and female. **2**

CB17
 Telecom Connectors,
 IEEE 488
 (Item 747)

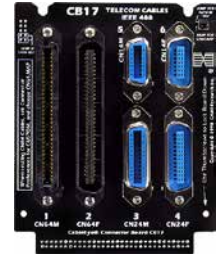

Item 748, CB18 Connector Board Set for RJ45 Multi-Head (Octopus) Cables.....

2

Item 748A, CB18A, for SHIELDED Connectors.....

Eight identical RJ45 modular sockets (8p8c) are provided. Use one at a time, or up to eight simultaneously. Mix one of these boards with any other CB board on the other side to test octopus and other multi-headed cables. *Requires 152 test points* (M3Z or higher). **2E**

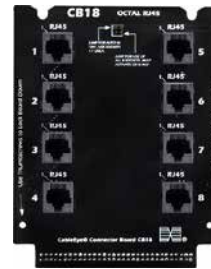

CB18
 Multiple RJ45
 (Item 748)

**Requires Expansion Module for HVX!*



CB18A
 Multiple Shielded RJ45
 (Item 748A)

Item 748B, CB18B Connector Board Set for Multi-Head RJ12/11 Cables Connectors.....

TEN unshielded RJ12 sockets (6p6c). **2**

CB18B
 Multiple RJ12
 (Item 748B)



Item 748C, CB18C Connector Board Set for Multi-Head (Octopus) RJ45 Shielded Cables.....

Same as CB18A (Item 748A), but with pluggable connectors. Includes a removable holding plate, which holds and aligns RJ45 connectors for insertion in the CB18C board. **2E**

For high-volume production environments: Replace worn connectors easily by removing hold-down plate. Includes 16 replacement connectors. *Requires 152 test points. Not compatible with M2U-Basic/M2Z.* **2E**

**Requires Expansion Module for HVX!*



CB18C
 Multiple Shielded RJ45,
 Pluggable Sockets
 (Item 748A)

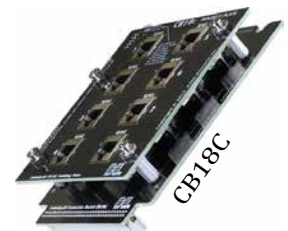

Item 749, CB19 Connector Board Set for Audio Cables.....

Includes XLR 3-pin shielded male and female, dual Phono Jack, 1/4" phone jack mono, 1/4" phone jack stereo, 1/8" phone jack mono, 1/8" phone jack stereo, DIN5 (for MIDI cables), Neutrik Speakon 2- and 4-pole, and four conductor pushpin terminal. **2**

CB19
 Audio Cables
 (Item 749)



NOTE: Unless specified otherwise, CB boards on this page are rated for operation at 500 V dc/ac. CAMI boards can be factory certified for operation at the maximum board-rated voltage for a service fee.

Item 750, CB20 Connector Board Set for SCSI III and Ultra SCSI Cables (mini-Centronics Connectors).....

Item 751, CB21 Connector Board Set for SCSI III and Ultra SCSI Cables (mini-D connectors).....

1 CB20 and CB21 are identical in design but employ different connector styles. Three connectors in sizes of 68 pins, 80 pins, and 100 pins permit testing of fast-wide SCSI cables or other types using these connectors. *Requires 256 test points.* Bare board available for other large-format connectors that fit the 4-row staggered-pin footprint of these connectors; contact us for details and pricing for the bare board version. **2E**

Fast, Wide SCSI Cables

CB20
(Item 750)
(mini-Centronics)



CB21
(Item 751)
(mini-D)



Item 753, CB23 Connector Board Set for mini-Centronics and CHAMP FH Connectors.....

1* Includes the most common sizes of mini-Centronics style connectors (also known as CHAMP FH) used in SCSI II and III, parallel printer ports (36-pin), and other applications requiring high density impedance-controlled connections. Board includes female connectors with 20, 26, 36, 50, and 68 pins. *Requires 152 test points; 68 pin connector not compatible with Model M2U-Basic/M2Z testers and requires expansion module with HVX series testers.* Bare board available for other connectors that fit the 4-row PCB footprint of these connectors; contact us for details and pricing for the bare board version. **2E**

CB23
Mini-Centronics
and CHAMP Cables
(Item 753)

**Requires Expansion
Module for HVX for
68 pin connector!*



Item 754, CB24 Connector Board Set for High-Density IDC Flat Cables.....

1 Use CB24 to test high-density flat cables with IDC wiremount sockets (0.025" wire centers, 0.050 x 0.100" pin centers). Four-wall headers for 100-pin, 80-pin, and 68-pin cables are provided on each board. *Requires 256 test points; expansion module needed; see p.8.* Bare board available for other large-format connectors that fit the 2-row footprint of these connectors; contact us for details and pricing for the bare board version. **2E**

CB24
High-Density
IDC Flat Cables
(Item 754)

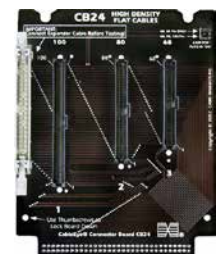

Item 755A, CB25A **See p.43**

NOTE: Unless specified otherwise, CB boards on this page are rated for operation at 500 V dc/ac. CAMI boards can be factory certified for operation at the maximum board-rated voltage for a service fee.

Specialized Boards for M3U-series Models Only

Item 755, CB25 Connector Board Set, M3U/H Control Module Transient Suppressor Board for High Static Environments and Long Cables

Use when regularly testing cables longer than 10 ft (3 m), when testing cables with a large surface area shield or conductor, or when working in a high-static environment to guard your M3U tester against damage from electrostatic discharge. On each board, 64 transient suppressor diodes especially designed for fast switching divert any overvoltages to ground before damage to tester electronics can occur. The CB25 mounts to the control module like any CB board and is physically secured with supplied stainless steel thumbscrews. **Once installed, do not remove.** Attach your test CB boards directly to the CB25. 2

CB25
 Transient
 Suppressor Board
 (Item 755)



Item 755X, CB25X Connector Board Set, M3U/H Expansion Module Transient Suppressor Board for High Static Environments and Long Cables

A variant of the CB25 designed for expansion modules. **Once installed, do not remove.** 2

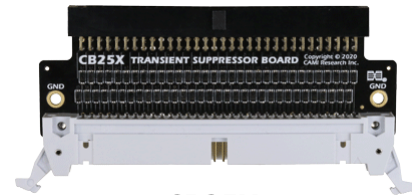

CB25X
 Transient Suppressor Board
 for Expansion Modules
 (Item 755)

System will require calibration with installed CB25/X.

For an explanation of how cables can become charged with static electricity and damage test equipment, go to:

camiresearch.com/protect-your-tester

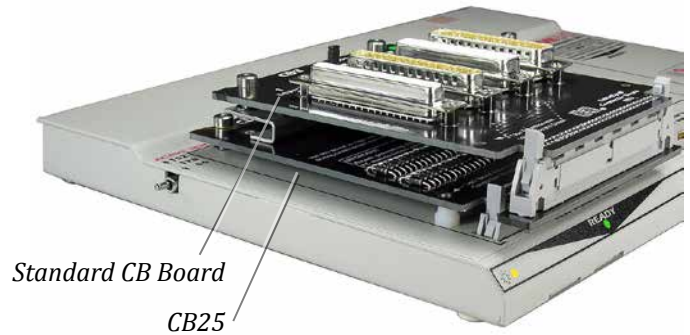

“Our production guys find it [our CableEye tester] simple to setup and use. Our clients love it as it provides complete traceability for each and every cable assembly we manufacture.”

AP Technology, UK

photo credit: AP Technology



NOTE: Unless specified otherwise, CB boards on this page are rated for operation at 500 V dc/ac. CAMI boards can be factory certified for operation at the maximum board-rated voltage for a service fee.

Item 756, CB26 Small Frame Motherboard.....

Provides the support frame part of our two-board system of mounting connectors available only in right angle format. Uses two 68-pin 2 mm headers designed to mate with any of the plugboards described below (sold separately). Up to two plugboards may be attached simultaneously and are held in place with right-angle brackets. [2]

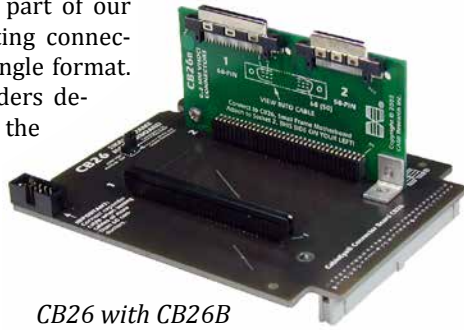

CB26 with CB26B Assembled



CB26 Small Frame Motherboard (Item 756)

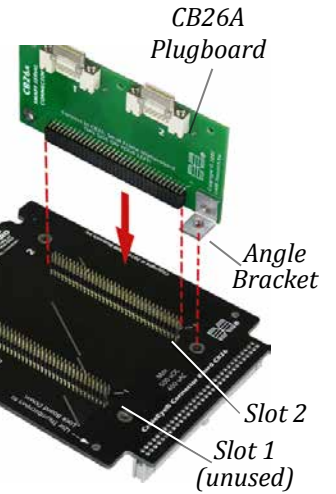

CB26 Small Frame Motherboard

NOTE: You need a CB26 Small Frame Motherboard to mount the CB26 plugboards described below and on the next page. Up to two plugboards may be attached simultaneously to one motherboard. All plugboard are sold in sets of two boards.

Item 756A, CB26A Plugboard for 26-pin Smart Serial Connectors.....

Two Cisco-style 26-pin Smart Serial connectors. Connectors may be used independently or together for a multi-ended cable. [2]



CB26A Smart Serial Connectors (Item 756A)

Item 756B, CB26B Plugboard for 50-pin and 68-pin 0.8 mm VHDCI Connectors.....

Two 0.8mm VHDCI connectors, one of 50 pins and the other of 68 pins. [2E]



CB26B 0.8 mm VHDCI Connectors (Item 756B) **Requires Expansion Module for HVX!*

Item 756C, CB26C Plugboard for 4-, 6-, 8-, and 10-pin Modular Plugs.....

Supports four sizes of modular plugs. The 4p4c jack for handset cords, a 6p6c jack for RJ11/RJ12 cables, a shielded 8p8c jack for RJ45 cables, and a shielded 10p10c jack for RJ48 cables. [2]



CB26C RJ Modular Connectors (Item 756C)

Item 756D, CB26D Plugboard for Serial ATA, USB miniB, and IEEE1394b (Firewire) Connectors.....

Footprint for 1394b connector (9 pins, two shields) connector not included, USB miniB connector (5 pins, shield), and Serial ATA connector (7 conductors). [2]



CB26D SATA, USBmB, 1395b Connectors (Item 756D)

Item 756E, CB26E Plugboard for HDMI (High Density Multimedia Interface) Connectors.....

CB26E provides two 19-pin HDMI connectors. [2]



CB26E HDMI Connectors (Item 756E)

Item 756F, CB26F Plugboard for Molex InfiniBand™ Connectors.....

Accepts the 25-pin InfiniBand™ connector. Two independent connectors are provided. [2]



CB26F Infiniband Connectors (Item 756F)

Item 756G, CB26G Plugboard for Shielded Data Link™ (SDL) Connectors.....

Accepts 4-, 8-, and 16-pin SDL connectors used in data, communications, and medical applications. [2]



CB26G SDL Connectors (Item 756G)

NOTE: Unless specified otherwise, CB boards on this page are rated for operation at 500 V dc/ac. CAMI boards can be factory certified for operation at the maximum board-rated voltage for a service fee.

Item 756H, CB26H for iPass Connectors.....

Accepts 36-pin external and 26-pin internal iPass connectors. The internal connector mounts along the short edge of the board. 2

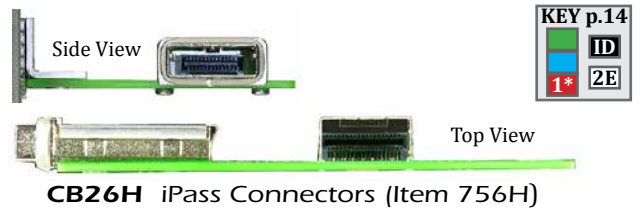

CB26H iPass Connectors (Item 756H)

Item 756i, CB26i Quad Serial ATA Connectors.....

Accepts four independent SATA connectors. All four connectors may be simultaneously connected and used to test dual or quad cables. 2

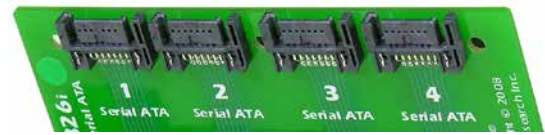

CB26i Quad SATA Connectors (Item 756i)

Item 756K, CB26K for Displayport Connectors.....

Accepts two Displayport connectors. 2



CB26K Displayport Connectors (Item 756K)

Item 756L, CB26L for MicroD 9-, 15-, and 25-pin Female Connectors.....

Accepts 9, 15, and 25-pin MicroD *Female* connectors. See CB41-44 for the full range of Micro D sizes and genders, p.28. 2



CB26L MicroD 9-, 15-, and 25-Pin (Item 756L)

Item 756M, CB26M for Foxconn Docking Connectors.....

Accepts two 30-pin Foxconn Docking connectors. 2

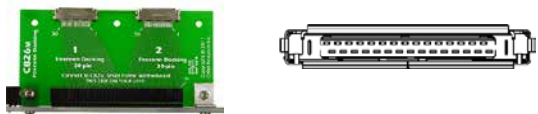

CB26M F30-Pin Foxconn Docking (Item 756M)

Item 756N, CB26N for USB 3.0A, 3.0B, and MicroUSB 3.0 A/B Combo Connectors.....

Accepts any USB 3.0 connector with two independent 3.0A and 3.0B connectors, and a single side-mounted microUSB 3.0 A/B Combo. 2

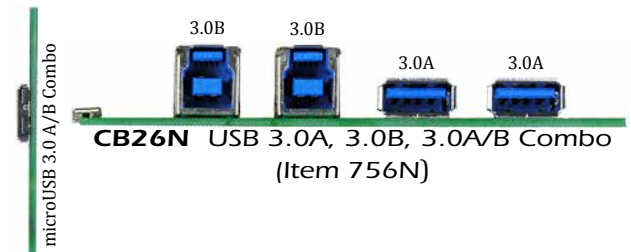

CB26N USB 3.0A, 3.0B, 3.0A/B Combo (Item 756N)

Item 756S, CB26S Plugboard for Mini-SAS/SFS Connectors.....

CB26S for mini-SAS (Serial Attached SCSI) accepts 36-pin connectors, and SFS 20-pin connectors, used in high-speed peripheral and server applications. 2

Item 756T, CB26T Plugboard for Mini-HDMI and mini-Displayport Connectors.....

Two independent mini-HDMI connectors, and two independent miniDisplayport connectors. **ID** B1245 or later. 2

Item 756U, CB26U for USB C Connectors.....

Accepts two USB Type-C connectors. Both can be used simultaneously. **ID** B1506 or later. 2

Item 756V, CB26V for FI-X Connectors.....

Accepts two FI-X 30 pin connectors. Both can be used simultaneously. **ID** B1506 or later. 2

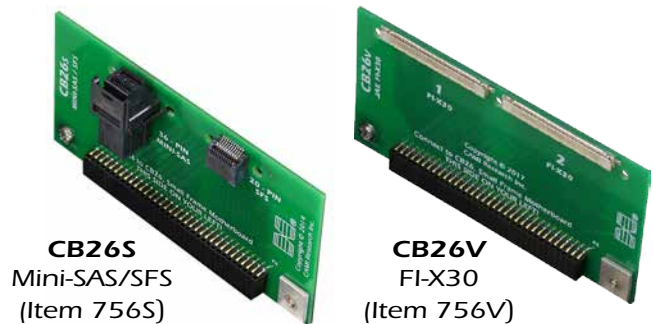

CB26S
Mini-SAS/SFS
(Item 756S)

CB26V
FI-X30
(Item 756V)



CB26T Mini-HDMI Mini-Displayport (Item 756T)

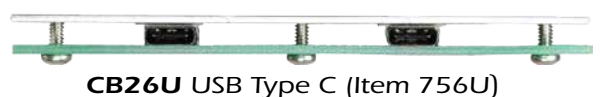

CB26U USB Type C (Item 756U)

NOTE: Unless specified otherwise, CB boards on this page are rated for operation at 500 V dc/ac. CAMI boards can be factory certified for operation at the maximum board-rated voltage for a service fee.

Item 757, CB27 Bare Wire Transition Board for 64 Conductors

For operation beyond 1500V, certification fee required.

CB27 employs 16 quad pushpin blocks to provide an interface for cables or harnesses that terminate in bare wires. Up to 64 wires can be accommodated per board. While similar to screw terminals, the pushpin blocks use spring-loaded levers that open easily with finger pressure and, when released, clamp down on a bare wire to hold it firmly in place. This provides very fast attachment and removal of bare wire connections. For longer-term set-ups, holes along the sides allow the use of wire ties to control wire bundles that exit from either side. Each 6.4 x 10.9" board, made using rugged 0.093" thick fiberglass, includes rubber feet for tabletop use. Corner holes allow the boards to be stacked or screwed down to a fixed surface. Includes an 8" long 64-conductor extension cable for direct connection to the tester. 0.1" pushpin opening will easily accept wires up to 18-gauge or one prong of a lug. **Rated to 500V with flat cable (provided), or to 2100Vdc/1200Vac with Ampmodu cable (order 12" of Item 864, p.42).**

1E

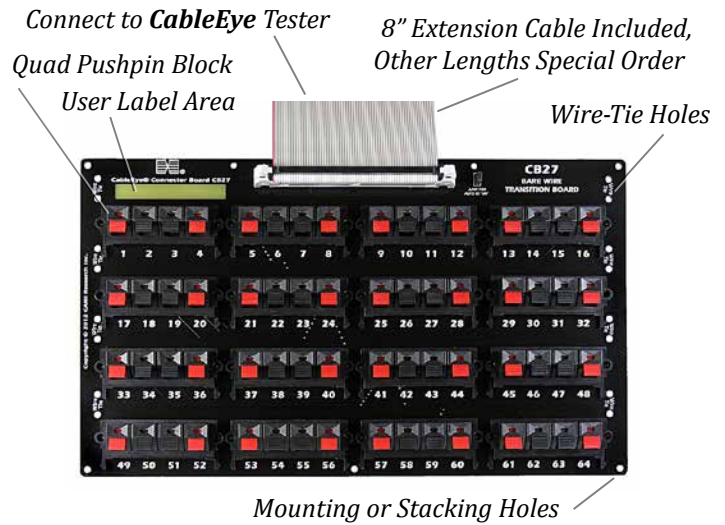

CB27
 Bare Wire Transition Board
 (Item 757)



Replacement Pushpin Connector
 (Item 757C)

Item 757P, Replacement Pushpin Connector

This connector replaces worn connectors on the CB27 board.

Item 758, CB28 Connector Board Set for TE Connectivity MATE-N-LOK™ Connectors



This board includes connector footprints for **MATE-N-LOK™** connectors with 0.163" and 0.250" grid spacing. The footprint patterns were sized so that the largest connector in the family will fit. Refer to example connector configurations below. Because of the wide variety of connectors available for this board and the many possible customer configurations. Customers should obtain their own mating connectors suitable for their application from their local TE Connectivity distributor. Software automatically sizes the connector graphics to fit the measured wiring. There are large-diameter holes on all footprints so that they will accept either standard production connectors or TE Connectivity's test probe connectors with wide-gauge spring-loaded pins. Use the test probe connectors to preserve connector life during high-volume production. **2**

Example Mating Connectors Available from TE Connectivity:

- 1-172162-9, 12-pin Matrix Socket (female), 0.163" Centers
- 794072-1, 24-pin Dual-Row Header (male), 0.163" Centers
- 643406-3, 5-pin Pin Strip (male), 0.250" Centers
- 194013-1, 15-pin Pin Matrix (male), 0.250" Centers
- 350848-6, 2x3 Pin Spring-Loaded Test Probe, 0.250" Centers

When ordering connectors, choose post length suitable for a 0.093" thick PCB (the board thickness of CB28).

CB28
MATE-N-LOK
 Connectors
 (Item 758)

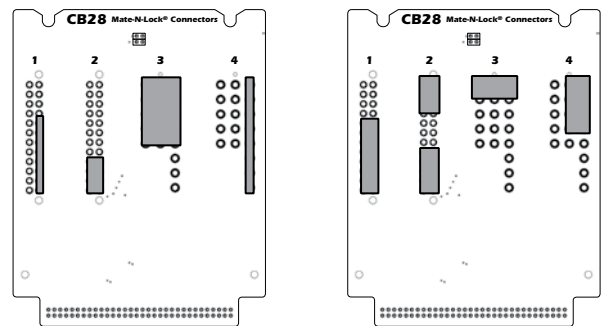
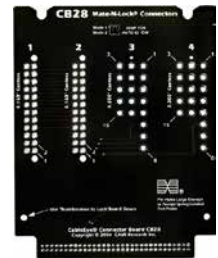

Example Configurations

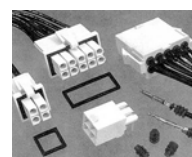

Example MATE-N-LOK Connectors
 (not included with CB28 Boards)

NOTE: Unless specified otherwise, CB boards on this page are rated for operation at 500 V dc/ac. CAMI boards can be factory certified for operation at the maximum board-rated voltage for a service fee.

Item 759, CB29 Connector Board Set for Bare Wire Connections.....

This board has four 16-pole screw terminal blocks (64 terminals, total) that will accept bare wires from 12- to 30-gauge in size. The metal jaws firmly grip an inserted wire without damaging or distorting the end. We normally include the terminal blocks shown in the photo, soldered in place and ready to use. These terminal blocks have 5 mm (0.197") spacing between the contacts. The board may also be supplied without terminals for customer-mounted terminal blocks (order Item 759BB shown below). The board footprint includes hole patterns for 5 mm (0.197") hole spacing for each of the four rows, so any type of terminal block with this spacing can be accommodated. The space between each 16-pole terminal block may be used as a wire channel to guide bundles of wires neatly to the side. A pair of holes is provided on the right through which wire ties may be inserted to hold the wire bundles in place. Note: terminal block color may be either blue (as shown) or black, depending on availability. **Rated to 1500Vdc/1000Vac with Ampmodu cable.** [2]

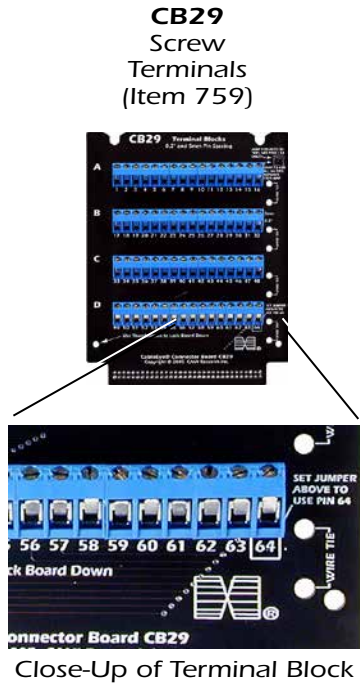

CB29BB Bare Screw Terminal Board (Item 759BB)

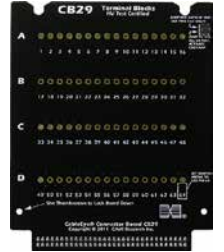

Item 759H, CB29H Connector Board Set for Bare Wire Connections.....

For operation beyond 1500V, certification fee required.

Same as CB29 (above) but **rated to 2100 Vdc/1200 Vac.** [2]

Item 759A, CB29A Wire Harness Transition Board.....

This variation of the CB29 board serves as a transition board between wire harness mating connectors and the CableEye tester. Mount the CB29A on or under a harness board, terminate the mating connectors to screw terminals on this board, and connect the 64-pin right-angle headers to the tester using 64-conductor flat cable (not included, see Item 854, p.42). Stackable, as shown in the photo. **Rated to 500Vdc with flat cable, or 1500Vdc/1000Vac with Ampmodu cable.** Includes kit of screws and standoffs. [2]



CB29H HV Screw Terminals (Item 759H)



CB29AH HV Wire Transition Board (Item 759AH)

CB29A Wire Transition Board (Item 759A)

CB29A is sold as a set of two boards. Three boards are shown stacked in this photo for illustrative purposes only.



Item 759AH, CB29AH Connector Board Set for Bare Wire Connections.....

For operation beyond 1500V, certification fee required.

Same as CB29A (above) but high-voltage **rated for 2100Vdc, 1200Vac when used with Ampmodu discrete-wire extension cable** (not illustrated, not included). See p.42 for Ampmodu Extension Cable, Item 864. [2]

Item 759BB, CB29BB Bare Wire Harness Transition Board (no terminal blocks, 1500Vdc, 1000Vac).....

Item 759HB, CB29HB Bare Wire Harness Transition Board (no terminal blocks, 2100Vdc, 1200Vac).....

For operation beyond 1500V, certification fee required.

Same as CB29 and CB29H (above) but with no terminal blocks installed. Use with your own terminal blocks, as an adapter cable interface, or for other purposes. [2]

NOTE: Unless specified otherwise, CB boards on this page are rated for operation at 500 V dc/ac. CAMI boards can be factory certified for operation at the maximum board-rated voltage for a service fee.

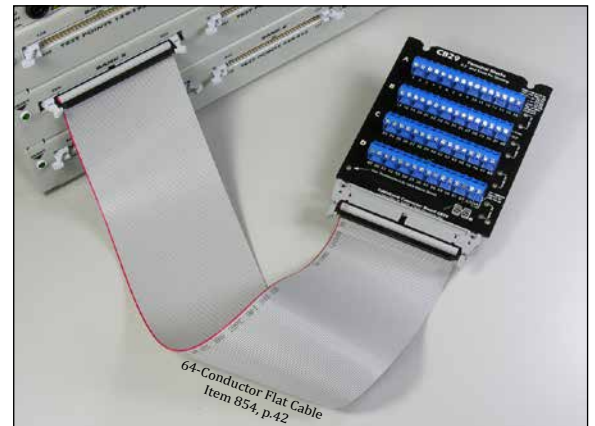

CB29A Connected to a CableEye Tester

Item 760, CB30 Connector Board Set for Custom Interfaces up to 128 Test Points on M-Series Models.....

Item 760H, CB30H Connector Board Set for Custom Interfaces up to 128 Test Points on HVX-Series Models.....

1 This generic board, similar in design to the CB8, accepts a wide range of circular connectors, rectangular connectors, bracket-mounted assemblies, adapter cables, and LIF test blocks. Mount your connectors using supplied standoffs and screws. Any panel-mount circular connector with four mounting holes fits the “X” pattern slots on this board. Mount up to four small circular connectors (mounting hole spacing less than 0.9”), or one large connector (mounting hole spacing less than 2.3”). Holes may be drilled in the board to accommodate other mounting arrangements. Wire pins from the attached connector to labeled pads surrounding the board. Use the numerous small holes around the board for nylon lacing to hold wiring in place. Alternatively, mount dual-row headers of up to 64-pins (Item 851, p.41) to the right and left footprints, spaced on a 0.1” grid. Use these headers for a custom-designed daughter board that plugs into the CB30 (see the CB30A through G boards, next pages) or for flat cables. Instead of a single 64-pin header, attach combinations of smaller headers that have a 0.1”x0.1” footprint. A total of up to 128 test points can be accommodated per board.

When the wiring is displayed, a generic dual-row header is shown for the connector. Use the optional **PinMap™** software (Item 708, p.37) to choose a different graphic from the **CableEye** connector library and assign custom pin labels. Use two CB30 boards together, or a CB30 in combination with any other CB board to accept any connector combination. *Requires 256 TPs.* **2E**

CB30

High-Capacity Custom Interface (Item 760)

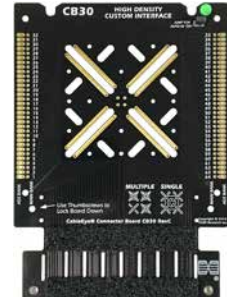

CB30 Standoff Kit

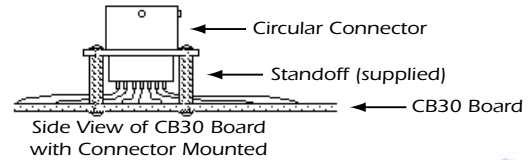

Side View of CB30 with 64-Pin Headers Attached (headers not included)

CB30 Mounted on a 256-Point CableEye System

CB30 Examples:
camiresearch.com/applications

Item 760A, CB30A Connector Board Set* for TE Connectivity MICTOR™ Connectors.....

1 This board supports 38-, 76-, and 114-pin surface-mount TE Connectivity **MICTOR™** connectors. A secondary bank in the lower part of the board provides backup footprints in the event that any of the connectors in the primary bank should become damaged or suffer intermittent connections from wearout. Pad spacing on this board is 0.025” (0.64mm), and the pads are arranged in groups of 38 (19 on each side).

Set of two boards* with four 64-pin latch headers. *Requires 256 test points and a set of CB30 boards.* Note that the latch headers supplied with the CB30A should be mounted to the CB30 boards to accommodate the 64-pin sockets on the bottom of the CB30A; CAMI Research will configure this for you if the CB30s are ordered at the same time as the CB30A. **2**



CB30A
MICTOR Connectors (Item 760A)



Side View of CB30 with 64-pin Headers Attached (headers included with CB30A or CB30B, not CB30)



CB30A Mounted on CB30

**IMPORTANT: These daughter boards mount on CB30/CB30H boards. Order CB30 or CB30H with these daughter boards if you don't already have a set.*

NOTE: Unless specified otherwise, CB boards on this page are rated for operation at 500 V dc/ac. CAMI boards can be factory certified for operation at the maximum board-rated voltage for a service fee.

Item 760B, CB30B Connector Board Set* for ITT Cannon DL-156, DL-96, DL-60 ZIF Connectors.....

The PCB footprint accepts any of three connector sizes: 156 pins, 96 pins, or 60 pins. Only one connector of these three sizes may be mounted on the board. Because of the complex and dense nature of these connectors, we do not advise customer-installation unless proper wave soldering equipment is available.

Note that these mating connectors are expensive and may require some lead time to obtain.

ITT Cannon Connector Part Numbers:

- 156 pins, DL1-156RW6B, Catalog #110536-1007
- 96 pins, DL2-96RW6B, Catalog #110855-0014
- 60 pins, DL3-60RW6B, Catalog #110901-0010

Set of two boards* with four 64-pin latch headers. *Requires 384 test points and a set of CB30 boards (Item 760, described on the previous page).* Note that the latch headers supplied with the CB30B should be mounted to the CB30 boards to accommodate the 64-pin sockets on the bottom of the CB30B; CAMI Research will configure this for you if the CB30s are ordered at the same time as the CB30B.



DL-156 Connector
Not Included



CB30B (Item 760B)
Mounted on
CB30 (Item 760)

Item 760C, CB30C Connector Board Set* for Molex 160-Pin LFH™ Connectors.....

For 160-pin Molex **LFH™** (low-force helix) connectors. Because of the complex and dense nature of these connectors, we do not advise customer installation unless proper wave soldering equipment is available.

Note that these mating connectors are expensive and may require some lead time to obtain.

Molex Connector Part Number (two required): 71624-1003
Mating connector is *Male* for *Female* Cable Connector

Set of two boards* with four 64-pin latch headers. *Requires 384 test points and a set of CB30 boards (Item 760, described on the previous page).* Note that the latch headers supplied with the CB30C should be mounted to the CB30 boards to accommodate the 64-pin sockets on the bottom of the CB30C; CAMI Research will configure this for you if the CB30s are ordered at the same time as the CB30C.

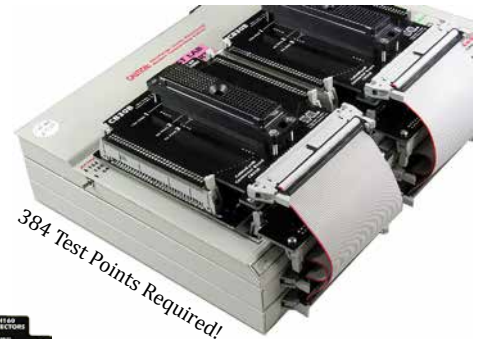

◀Mounts on tester like CB30B above

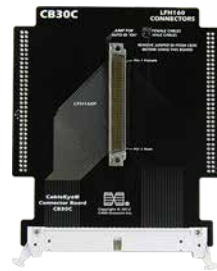

CB30C
Molex 160-Pin
LFH Connectors
(Item 760C)



CB30D
Molex 200-Pin
LFH Connectors
(Item 760D)

Item 760D,E,F,G, CB30D,E,F,G Connector Board Set*

See Table at right.

**IMPORTANT: These daughter boards mount on CB30/CB30H boards. Order CB30 or CB30H with these daughter boards if you don't already have a set.*

NOTE: Unless specified otherwise, CB boards on this page are rated for operation at 500 V dc/ac. CAMI boards can be factory certified for operation at the maximum board-rated voltage for a service fee.

CB Board	Connector Type			# Exp. Modules Req'd	ID
CB30D	Molex	LFH	200-pin		V6.1
CB30E	TE	MICTOR	Full Range	to	B1245
CB30F	Joy Signal	Compact Brute	CB-140		V6.1
CB30G	Cannon	ZIF	DL5-260		B1780

All Available on Special Order: Contact us for Details and pricing.

Item 761, CB31 Connector Board Set for METRAL® Connectors.....

 We designed the CB31 for **METRAL®** connectors (manufactured by FCI) which have 4 x 24 and 5 x 6 pin layouts on a 2 mm grid. Easily solder in your connectors of the needed sizes. When using 4 x 24 (96-pin) and 5 x 6 (30-pin) connectors with the Auto-ID jumper in place, the **CableEye** software automatically assigns the pin numbers as defined by the manufacturer for connectors of these sizes. For smaller connectors, use the optional **PinMap™** software (Item 708, p.37) to select an appropriate graphic and assign pin labels. *Requires 256 test points.* 2E

**CB31
METRAL Connectors
(Item 761)**

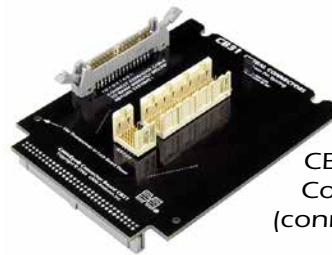

CB31 with METRAL Connectors Mounted (connectors not included)

Item 762, CB32 Connector Board Set for DB104 High Density Connectors.....

 For DB104 male or female connectors. Easily solder in your connectors: one vertical male or female connector on each board, as needed. *Requires 256 test points.* TE Connectivity: 208877-1, DB104 Receptacle, 208871-1, DB104 Plug. 2E

**CB32
DB104 Connectors
(Item 762)
(connectors not included)**

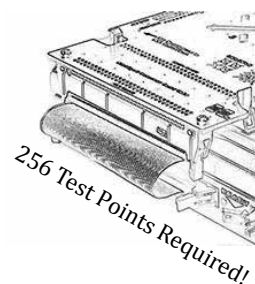
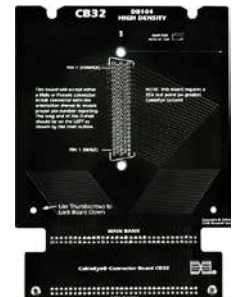

CB32 Mounted and Connected to Expansion Module

Item 763, CB33 Connector Board Set for Molex MiniFit®, MiniFit Sr., and MicroFit™ Connectors.....

 Includes connector footprints for **MiniFit®** connectors with 0.118", 0.165", and 0.394" pin centers. The footprint patterns were sized so that the largest connector in the family will fit. Connector graphics are automatically sized to fit the measured wiring. 2

**CB33
MiniFit, MicroFit Connectors
(Item 763)
(connectors not included)**

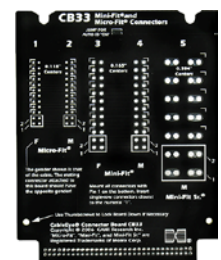

Item 764, CB34 Connector Board Set for Cirris™ Adapter Cards.....

Will accept one 64-point Cirris adapter board or two 32-point Cirris adapter boards, and show test results as a 64-pin header numbered 1-64 on each bank. The **CableEye** software does not compute the board or cable Signature, or automatically identify which Cirris board is connected. Use the **PinMap™** software, p.37, to obtain a proper graphic and pin numbering. Most Cirris-made boards are numbered so that the test point number corresponds with the connector's pin number, so the pin numbering shown on the 64-pin header will be correct even if the graphic is not. You may use this board with **CableEye** HVX systems. **Rated to 1500 Vdc/1000 Vac** assuming that a suitably-rated Cirris board is also used. 2

**CB34
Cirris™
Adapter Interface
(Item 764)**



NOTE: Unless specified otherwise, CB boards on this page are rated for operation at 500 V dc/ac. CAMI boards can be factory certified for operation at the maximum board-rated voltage for a service fee.

- Item 765, CB35 Relay Control Board for External Digital Control (Not compatible with M2U-Basic/M2Z).....
- Item 765, CB35 Relay Control Board for External Digital Control (Not compatible with M2U-Basic/M2Z).....
- Item 768P, +5v Accessory Power Module (needed when 3 or more relay boards are cascaded).....



CB35
Relay Board
(Item 765)

Ten independently-controlled SPDT relays with dry contacts allow program control of circuits associated with the UUT. Issue Macro or JavaScript commands to close or open a relay coil, then perform the test. Other uses: illuminate a bin where a failed cable should be placed; illuminate different bins to show locations for devices sorted by resistance or resistance tolerance; trigger a visual or audible signal indicating the end of a batch; signal a marking device to emboss test results on a wire or connector.

Mount the relay board in either Banks 1 or 2. It uses no test points on that bank; special brackets allow a standard CB board to be mounted *above* the relay board to operate in the normal manner using all 64 pins in that bank position.

For HVX-series testers, attach the CB35 to a riser board (Item 755A) or set elsewhere on the bench. The CB35 must be used in this detached mode when test voltages exceed 250 V.

Each relay coil has an associated LED lamp which turns on when the coil activates. The terminal block provides three output terminals for each relay: Common, Normally Open, and Normally Closed. The jumper configuration on the board lets you leave all relay common terminals floating, tie the common terminals together linked to an external common, or tie the common terminals to the local signal ground.

The screw terminal blocks accept 12- to 30-gauge bare wires and have 5 mm (0.197") spacing between the contacts.

Each board includes a control cable that links to the tester. With the exception of the M2U, multiple relay boards may be used at the same time. The relays operate at +5 V and derive power from the tester which can supply two relay boards. An external +5V supply is required for more than two boards. Independent Power and Ready LEDs show the status of the board.

CB35 64-Pin Headers are **rated to 250 Vdc/ac**. This is NOT the operational voltage of the relays.

1

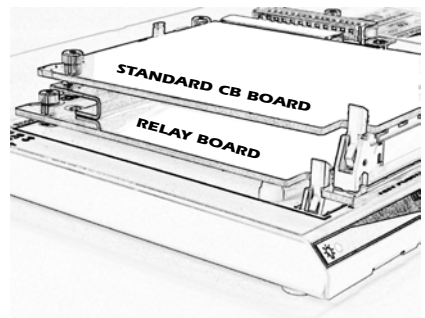

Mounting a Standard CB Board Above the Relay Board

From Tester REMOTE Socket
To 2nd Relay Board or Footswitch

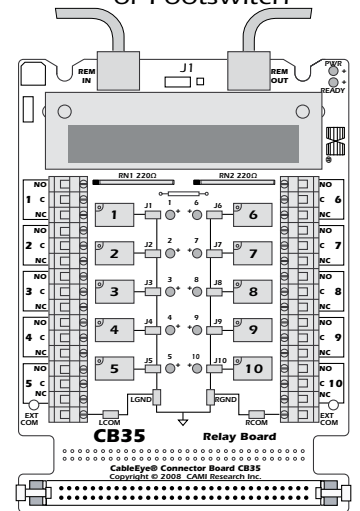

Relay Specifications	CB35	CB35H
Relay Type	Omron G5V-1 or Equivalent	Omron HY1-5V or Equivalent
Contact Load	0.5 A at 125 Vac, 1 A at 24 Vdc	0.5 A at 125 Vac, 1 A at 30 Vdc
Contact Resistance	100 mΩ max	100 mΩ max
Bounce Time	0.2ms (operate), 5ms (release)	0.2ms (operate), 4 ms (release)
Insulation Resistance	1000 MΩ min	1000 MΩ min
Dielectric Strength	400 Vac, 50/60 Hz between contacts	500 Vac, 50/60 Hz between contacts

- Item 770, CB40 Connector Board Set for Elco/Edac 20-, 38-, and 56-pin Rack & Panel Connector (used in Audio Patch Panels).....

Three connector positions provided on this board will accept either a male or female 20-, 38-, and 56-pin Elco/Edac Rack & Panel connectors.

2

CB40
Small Elco/Edac Rack & Panel Connectors
(Item 770)

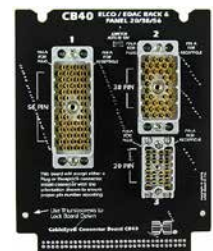

NOTE: Unless specified otherwise, CB boards on this page are rated for operation at 500 V dc/ac. CAMI boards can be factory certified for operation at the maximum board-rated voltage for a service fee.

Item 771, CB41 Connector Board Set for 21-, 25-, 31-, and 37-Pin Micro D Connectors.....

2

See next description.



Item 772, CB42 Connector Board Set for 9-, 15-, and 51-Pin Micro D Connectors.....

2

Both CB41 and CB42 have footprints for small- and medium-size Micro D connectors. Each board has one position for male and female connectors of each size.



Item 771A, CB41A Connector Board Set for 21-, 25-, 31-, and 37-Pin Nano D Connectors.....

2

Same as CB41 but for Nano-D style connectors.



Item 772A, CB42A Connector Board Set for 9-, 15-, and 51-Pin Nano D Connectors.....

2

Same as CB42 but for Nano-D style connectors.



Item 773, CB43 Connector Board Set for 9-, 15-, 21-, 25-, 31-, and 37-Pin Micro D Connectors.....

2

See next description.



Item 774, CB44 Connector Board Set for 51 and 100-Pin Micro D Connectors.....

2E

Both CB43 and CB44 provide connector footprints for Micro D connectors. Each board offers one position only for each size. A jumper on the board configures the board for the proper connector gender. The CB44 offers a footprint for a 100-pin connector, requiring a 256-point tester.



Item 775, CB45 Connector Board Set 1mm and 0.5mm Surface-Mount Connectors.....

2

Accepts single- and dual-row surface-mount connectors with 1mm aligned pins (32 x 32 max), 1mm staggered pins (26 x 25 max), 0.5mm aligned pins (32 x 32), and 0.5mm single-row pins (64 x 1).



Item 776, CB46 Connector Board Set for 100-pin MicroD Connectors, Airborn-style Footprint.....

2E

One connector position provided on this board will accept an Airborn-style 100-pin MicroD connector (6 rows of pins, (16-16-17-17-17-17)). Requires 256-points.



Item 777, CB47 Connector Board Set for DB62HD Connectors.....

2

Two connector positions each accept either male or female DB-62HD connectors. Specify your gender preference when ordering and the connectors will be mounted as needed.

Item 778A/B, CB48A/B..... See p.43



CB41 and CB41A
Micro and Nano D Connectors, 21-, 25-, 31-, 37-Pin (Item 771 and 771A)



CB42 and CB42A
Micro and Nano D Connectors, 9-, 15-, 51-Pin (Item 772 and 772A)



CB43
Micro D Connectors, 9- through 37-Pin (Item 773)

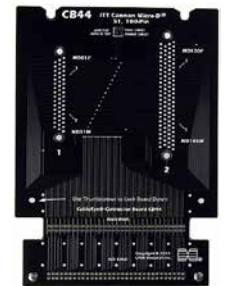

CB44
Micro D Connectors, 51- and 100-Pin (Item 774)

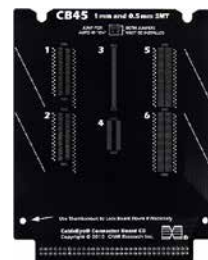

CB45
1 mm and 0.5mm SMT (Item 775)

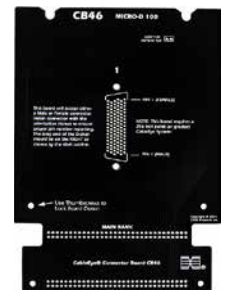

CB46
100-Pin Micro-D (Item 776)

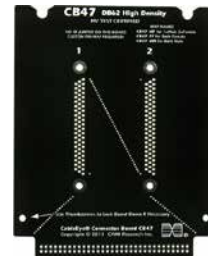

CB47
DB62HD (Item 777)

NOTE: Unless specified otherwise, CB boards on this page are rated for operation at 5 V dc/ac. CAMI boards can be factory certified for operation at the maximum board-rated voltage for a service fee.

Item 779, CB49 Connector Board Set for TE Connectivity MicroMaTch Connectors (SMD Style).....

 Nine 20-position SMD connector footprints are provided for customer installation of the desired connector sizes. Footprints are labeled for standard sizes ranging from 4 to 20 pins, and an auto-ID map is provided for these. However, the user can create a custom map, if desired, for any combination of connectors. **ID** B1245 or later. **2**

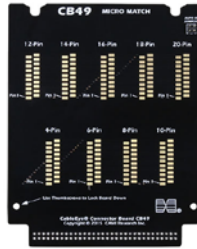

CB49
MicroMaTch
(Item 779)

Item 780A, CB50A See P.30
1

Item 781, CB51 Connector Board Set 1.25mm and 1.5mm Surface-Mount and Through Hole Connectors.....

 Contains four sets of 60 solder pads accommodating numerous configurations of surface mount and through-hole connectors – aligned or staggered pins at 1.25 mm and 1.5mm pitch. There are four preset locations for automatic detection & display of any-pin-count connector up to 60-pins. Any single set may be fitted with any combination of lower pin count connectors that total to 60 or less (e.g. a 40-pin with a 10-pin). Connectors soldered in non-preset positions will also appear graphically correct once they are mapped with **PinMap™** optional software. **ID** B1754 or later. **2**

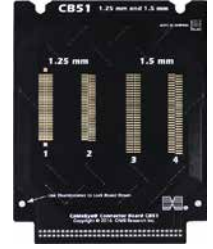

CB51
1.25mm and 1.5mm
SMT & TH (Item 781)

Item 782, CB52 See p.30
1

Item 783, CB53 4-Wire CB Board Conversion Set.....

 A special connector motherboard that will convert a top-mounted standard 64-pin CB Board fixture into a 4-wire test fixture. Conversion is valid when the UUT connects directly into the standard board rather than via a flying lead or adapter cable and eliminates the need to otherwise create custom 4-Wire test fixtures. *A system with 4-Wire measurement capability and with 256 test points is required to use this board.* Connectors will appear graphically correct once they are mapped with **PinMap™** optional software. **2E**

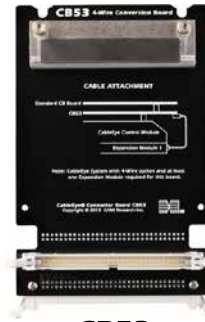

CB53
4-Wire Conversion
Board

*Requires
4-Wire
compatible
tester.*

Item 784, CB54 Connector Board Set for 4 to 26-pins Molex Picoflex® Connectors.....

 Contains footprints for the family of **Picoflex®** connectors. Positions for 4, 6, 8, 10, 12, 14, 16, 18, 20, 22, 24 and 26-pins are available. **2**



CB54
Molex Picoflex
Connectors

**Requires Expansion Module
for HVX when using more
than the lowest 30 pads in
any row.*

Item 785, CB55 Connector Board Set for 3M/ENRI Connectors.....

 **1*** Has surface mount pads for four dual row connectors at 0.05” (1.27mm) pin pitch with up to 68 pins: two each of different row separations. A single row connector can be soldered to any dual row location. The footprints are suitable for many connectors including those by 3M and ERNI. **ID** B1731 or later. **2**



CB55
3M/ENRI
Connectors

Item 786, CB56 Connector Board Set for 3.5mm Phoenix Contact Connectors.....

 Offers 6 positions for 20-pin Phoenix Contact connectors, or any other connector with a 3.5 mm pitch. Only closer pair shares test points, allowing to test a cable between pairs in the same board. **ID** B1754 or later. **2**

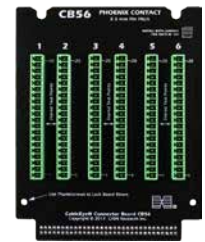

CB56
3.5mm Phoenix
Contact Connectors

Item 788, CB58 See p.30
1

NOTE: Unless specified otherwise, CB boards on this page are rated for operation at 500 V dc/ac. CAMI boards can be factory certified for operation at the maximum board-rated voltage for a service fee.

TRAINING, VALIDATION & VERIFICATION BOARDS

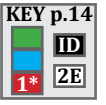

We recommend quarterly functional verification of your **CableEye** tester checking for correct fault detection, and measurement of resistance and capacitance (see the Appendix of your Manual).

Item 802, CB-T2 Training and Verification Board.....

This multi-purpose fixture can be used for operator training, demonstrations, tester system verification, and facility verification. Use to familiarize employees with the **CableEye** test system. Training may be self-directed with this board to quickly demonstrate how the system responds to opens, shorts, miswires, diodes, resistance, intermittent connections, capacitance and insulation resistance. As a system validation tool, the board allows customers to verify the tester functions properly by quickly sampling the full spectrum of fault detection without use of example fault cables. Includes downloadable Guide. **ID** B1893 or later **1**

CB-T2
Training and
Verification Board
▼ (Item 802)



Item 780A, CB50A 2-W Resistance Calibration Verification.....

Verify proper 2-wire resistance measurements. A range of precision resistors and two diodes cover all 64 test points available on this board and span values from 0.5 Ω to 4.6 M Ω . Manually move the board to additional banks and retest to cover all test points. If you have expansion modules, you may wish to order a CB48A **Header Isolator**[™] protective adapter, Item 778A shown on p.43, to permit connection of the board to expansion modules. **1**

CB50A
Calibration
Verification
Board
(Item 780A)

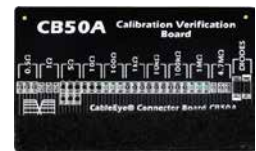

Item 782, CB52 4-Wire Resistance Calibration Verification.....

Verify proper 4-wire resistance measurements. 4-Wire testing is possible with the model M4 (20m Ω \pm 20 m Ω), and with HVX-series testers that were purchased with the Advanced Measurement option (20m Ω \pm 20 m Ω) or with the 4-Wire Measurement option (1 m Ω \pm 1m Ω). The 4-Wire Measurement option may be added to an existing high voltage tester as an upgrade. **1**

CB52
4W Calibration
Verification
Board
(Item 780)



Item 788, CB58 Capacitance Calibration Verification.....

Verify proper capacitance measurements. A range of 32 precision capacitors cover all 64 test points available on this board and span values from 51 pF to 10 μ F. Manually move the board to additional banks and retest to cover all test points. If you have expansion modules, you may wish to order a CB48A **Header Isolator**[™] protective adapter, Item 778A shown on p.43, to permit connection of the board to expansion modules. Includes a reference cable file calibrated uniquely for each serialized board. Requires M4, or HVX with Advanced Measurements option. **1**

CB58
Capacitance
Calibration
Verification
Board
(Item 788)



LIF, ZIF TEST INTERFACE FIXTURES

ZIF/LIF Fixture Manufacturer

Our Zero Insertion Force (ZIF) **Light Director**[™] guided assembly fixtures and Low Insertion Force (LIF), plug and play, electrical test interface fixtures are manufactured in partnership with Doyle Manufacturing.

Doyle blocks are CNC machined for the highest quality and accuracy and are available with a range of functionality: Pneumatic release lock blocks and electric solenoid release lock blocks for quality assurance; part presence detection for secondary locks, clips, etc.; step probes and push back switch probes for checking properly seated terminals, and light fibers for light-guided assembly. ZIF fixtures are assembled with light fibers rather than pogo pins and are used in conjunction with the **Light Director**[™] light-guided assembly accessory (p.34).



Header Isolator[™], **Light Director**[™] are trademarks of CAMI Research Inc.

All of these block functions can be monitored and controlled by **CableEye** software out-of-the-box automation capabilities and, if desired, may be supplemented with audible tones, visual tower lights and more. API integration with other equipment is also possible for electrical testing – **LabVIEW** and **.NET** libraries are available.

Blocks can free-float, or be mounted individually, on panels or on CB-style boards. An array of **QuickMount™** housings can be used if preferred. All fixtures ship with **CableEye** Connector Graphics Files for professional quality graphics display of connectors and cables.

LIF Electrical Test Fixture

A LIF fixture, also referred to as an electrical test 'block', can be ordered for electrical test when connector pin-to-pin centers are spaced by 1.27 mm (0.05") or greater. You will need to send a sample of the build connector with terminals if you order this type of fixture.

Zero Insertion Force (ZIF) Light Director Fixture

Our default **Light Director** fixture uses a ZIF fixture subassembly, also referred to as a **Light Director** 'head' or 'block'. In addition to presenting an even brighter light to the assembler, it provides easier and more rapid connection and disconnection of the connector being assembled achieving even greater productivity. This type of fixture is available when connector pin-to-pin centers are spaced by 1.5 mm or greater. You will need to send a sample of the build connector if you order this type of fixture.

Original Light Director Fixture

Our original **Light Director** fixturing uses an actual mating connector as illustrated on p35. The method requires attachment of the build connector to the mating connector on the fixture whether by screwing or pushing one onto the other. We recommend this approach when pin-to-pin centers are spaced by less than 1.5 mm. You will need to supply the mating connector and a sample build connector if you order this type of fixture.

ZIF/LIF Fixture Operation

Simply slide the connector into place - threaded connectors are NOT screwed onto the mating interface. Press the top of the fixture lightly to lock, and the lever to release.

The two types of fixtures can be placed next to each other so you can assemble on the **Light Director** block and then quickly move the UUT to the other for the electrical test. Or you can have them at entirely different stations on the production line.

Integrated Probe Plate Option

A 0.5" dia. integrated plate with banana jack and an 18" cable to connect it to the DB9 connector at the side of the tester.

Standalone Probe Plate Option

See probe accessories on p.43.

Contact us for pricing. Order Item 899C (see p.32 for details).



Unmounted LIF Block Sub-Assembly



Mounted LIF Block Sub-Assembly



ZIF Block with Integrated Probe Plate

CUSTOM INTERFACE DEVELOPMENT

Item 899C, Custom Connector Interface or Mating Harness Assembly, Quotation Provided on Request

We will design and build custom interfaces for your unusual cables and wire harnesses. The interface may employ Low Insertion Force (LIF) pogo-pin fixtures, mating connectors hard-wired to board (e.g. CB8, CB30), adapter cables, a connector panel, a mating harness, or other configuration based on our discussion with your technical personnel. See examples at right and below. After we develop an initial plan and receive sample cables and mating connectors from you, we will evaluate the requirements and provide you with a quotation. Allow two to four weeks for design and assembly after receipt of order. When complete, you will receive a "turnkey" solution - tested and ready to use, complete with setup instructions.

In order that we produce an accurate quotation, you need to provide us with:

- 1 - A sample cable or harness
- 2 - Mating connectors or adapter cables
- 3 - A wire list or schematic of the cable or harness
- 4 - A wire assembly sequence (for guided assembly projects)
- 5 - Any other material defined during the process

We offer a one-year warranty against defects in workmanship. Contact us for further information or to arrange sending cable samples and mating connectors.

Circular Connectors Mounted on a CB8 Board



Back Panel Testing with Flat and AMPMODU Mating Adapters

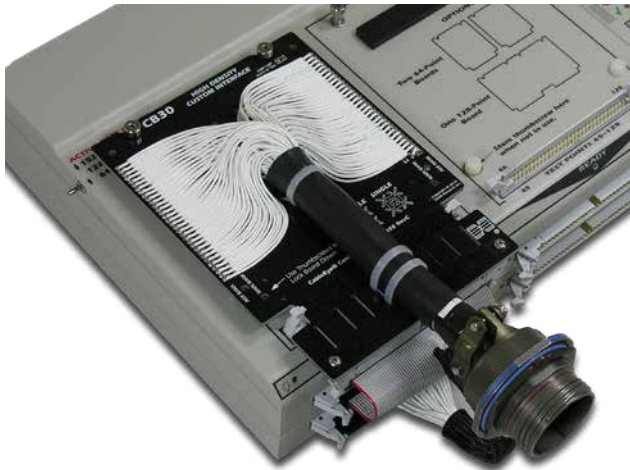
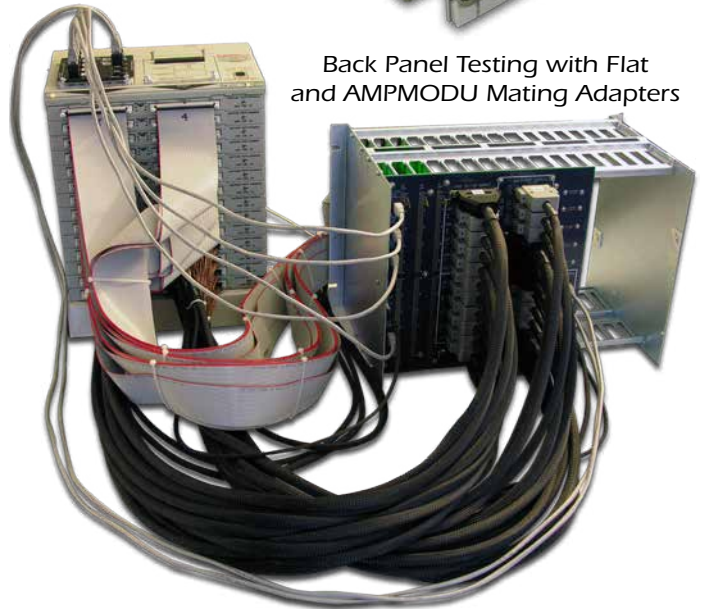

Connector Panel for Custom PLC Connectors and Flying Leads

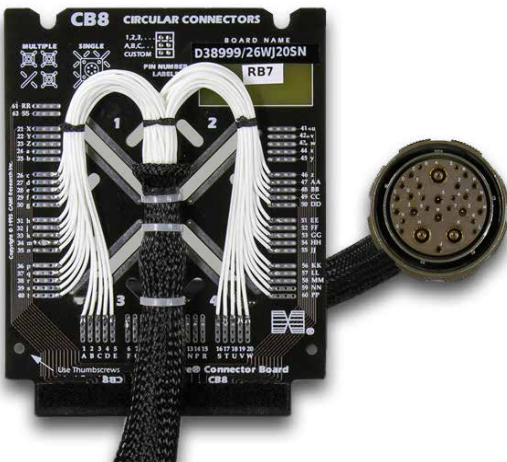

Low Insertion Force Pogo-Pin Electrical Test Fixture



FEATURE APPLICATIONS

Our future-Ready testers are used for countless applications in Transportation, Energy, Medical Devices, Defense, Scientific R&D, Telecom, and more.

If you would like to see your application featured in our catalog and other publications, please submit your high resolution photos to applications@camiresearch.com.



From Top, Clockwise:
 Live Entertainment Event Mobile Cable Testing Laboratory (photo EMG)
 Electric Vehicle Charging Cables (photo evcables)
 Military Slip Ring Testing (photo PVP AEO)
 Motorsport Steering Wheels (photo Creative Motorsport Solutions)
 Semiconductor Test Interface Fixture (photo Incore Technology)
 Connector Manufacturer Guided Assembly (photo Onanon)

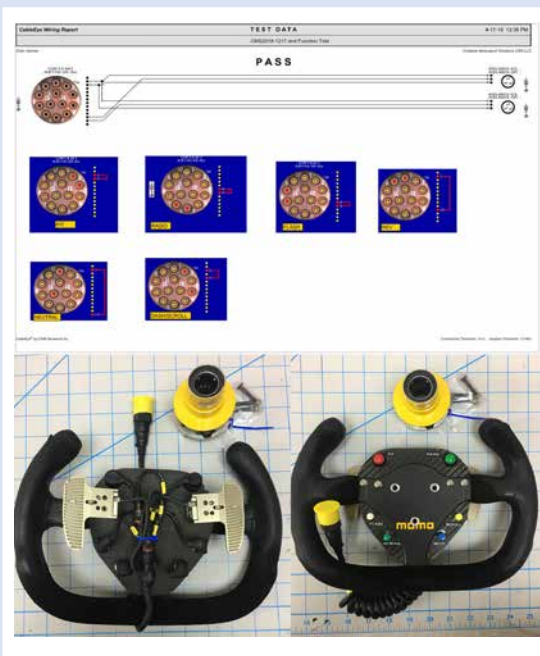

LIGHT-GUIDED CONNECTOR ASSEMBLY

Item 767A, CB37A, 64-Pin Light Director™ Board..... †

Item 768A, CB38A, 128-Pin Light Director™ Board..... †

KEY p.14
 CB37A and CB38A are not compatible with M2-series testers. Each board includes 64 - 6" long light fibers (128 with CB38A), connector support plate, mounting hardware, fiber shroud, and power cable. **AutoBuild™** software option required; see Item 728, p.40. **CB38A requires an expansion module! †ZIF Fixture (p.30), Assembly and Programming (Items 610/611) - Not Included.* **1**

Item 768P, +5v Accessory Power Module (needed when 2 or more CB38A boards are cascaded)

Item 858C, Kit of 32, 6" Long Extra Light Fibers

Item 858D, Light Fiber per foot.....

Item 610, Assembly and Programming of CB37A.....

Item 611, Assembly and Programming of CB38A.....

Using customer-supplied cable schematic or pin assignment table, we will mount the ZIF fixture or customer-supplied mating connector and program the assembly. Refer to p.30 for test fixture options. ZIF fixture purchased separately.

Our **Light Director™** system provides a computer-guided technique for assembling connectors used in aerospace, medical, and other high-reliability applications. This system uses light fibers and super-bright LEDs to individually illuminate target cavities in the connector being assembled. When the technician enters the wire code printed on unconnected wires, or touches a wire connected at the other end, the **CableEye** software turns on the appropriate fiber, thereby causing a bright, flashing light to project from inside the target cavity guiding the technician to the proper insertion point. Correct insertion is confirmed by the elimination of light from that location, whereas insertion into an incorrect location leaves the flashing light visible.

Using synthetic speech, **Light Director** can read the pin number to the technician, further reinforcing the target location. Speech can be activated in English, Spanish, French, German, Italian, Chinese, Hebrew, Japanese, Korean, Polish or Turkish when a matching generic voice font has been downloaded. Speech recognition is also available as an option permitting the technician to speak wire codes to the system, thus eliminating the need for a keyboard or monitor.

Normally, technicians crimp pins on wires in advance of assembly to the connector. Wires may be identified during the assembly process by numeric code, bar code, color code, or if no codes are present, by electrical detection using a wrist-strap if the far end of the cable has already been assembled and can be electrically connected to the system.

Field testing has shown that the **Light Director** doubles assembly rate over manual methods while nearly eliminating errors. Because the Light Director greatly reduces the perceptual challenge of manually locating pin cavities in a complex connector, *technician fatigue is greatly reduced*, permitting a continuous, high productivity rate throughout the work day.

The **Light Director** system is an accessory for CAMI's **CableEye** PC-Based cable test system models M3-Series and above. The CB37A or CB38A boards include everything needed to mount the customer-supplied mating connector or ZIF fixture. All parts are reusable. *Requires the **AutoBuild** Guided Assembly Software (Item 728); a high-quality voice font is optional (Item 792); see p.40.*



REDUCE ASSEMBLY ERRORS, INCREASE PRODUCTIVITY!



Videoclip Demo on CAMI Web Site

Ready-to-Use **Light Director** Assembly

Comprises Item 767A, Item 610, ZIF Fixture (p30)

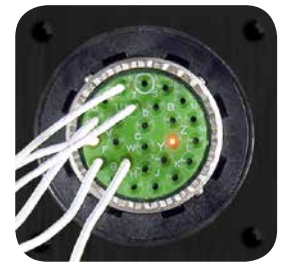

Flashing Light Shows Target Pin

**CB38A Requires Expansion Module!*



Side View Showing Fibers Entering Mating Connector

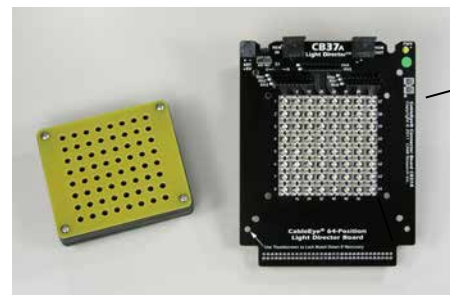

CB37A Board with 64 Mounted LEDs

Friction Block Gasket Used to Support Fibers (left)

LIGHT-GUIDED CONNECTOR ASSEMBLY

Light Director™ Bench Setup

In this photo, you see an original style fixture comprising a 55-pin mating connector mounted to a CB37A board. The connector to be assembled is on the bench along with the pre-pinned wires ready to be inserted. In this case, each wire is numbered to correspond with a printed insertion list. If assembled manually, the insertion list would tell the technician which cavity number should receive each numbered wire. The technician would then carefully locate the cavity, sometimes counting forward or backward from a reference location, and insert the pin into this cavity. During manual pin insertion, locating the correct cavity takes time and requires the technician's full concentration. **Using the Light Director system, the technician simply looks for the cavity with a flashing light and inserts the pin there.** Neither reading cavity numbers from the target connector nor counting forward or backward from a reference position is necessary. This reduces the perceptual challenge in finding the target, and therefore speeds assembly, improves accuracy, and reduces the fatigue level that would be experienced after several hours of manual pin-insertion work.

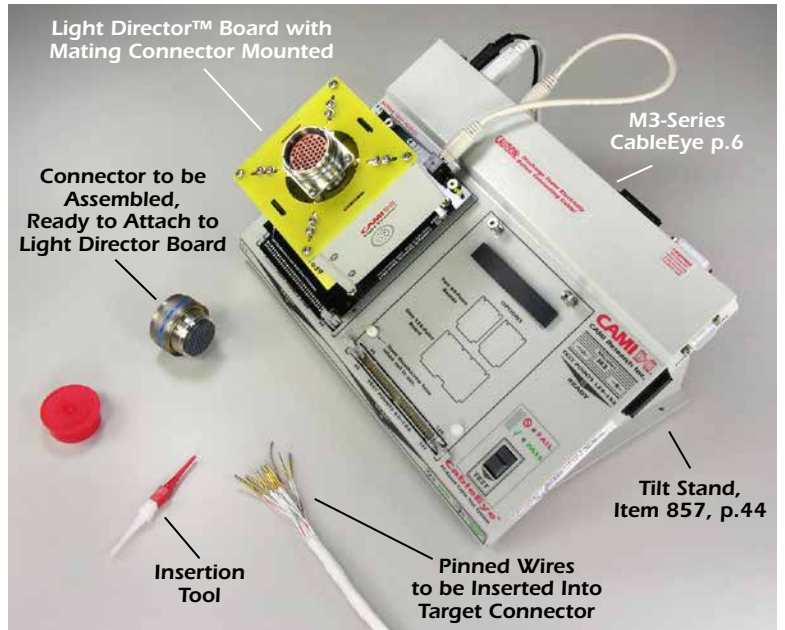

Moisture Plugs

Prior to pin placement, we illuminate all cavities requiring moisture plugs to allow rapid plug insertion. Blocking cavities not requiring pins further reduces the chance for insertion error.



Components of the CB37A Board Kit (Item 767A)

The reliable guided assembly and test system for your mission-critical applications ... aerospace, medical, etc.

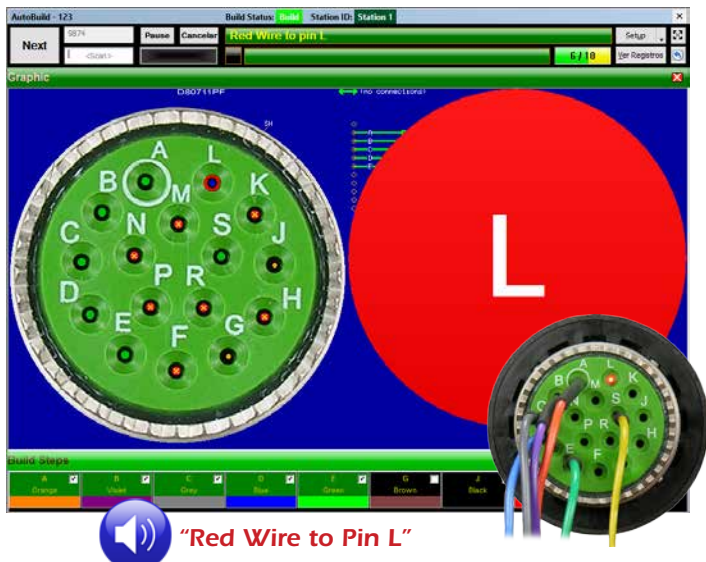

"... increases productivity ... ensuring correct wire to connector placement."









Rapid wire technology to terminate cable assemblies greatly increases yields, and reduces assembly costs. Real-time CAMI wire recognition technology greatly increases productivity ... ensuring correct wire to connector placement - all while performing in-process continuity & HiPot testing.

Dennis Johnson, CEO - Onanon Inc.

OPTIONAL SOFTWARE SELECTION GUIDE

Check if
Needed

Use the following guide to help you determine if you need optional software.

	<p>PinMap™ Fixture Editor Software, Item 708 Order PinMap software if:</p> <ol style="list-style-type: none"> you need to build a special fixture or adapt to your existing mating harnesses. you are using generic CB Boards like our CB8, CB30 or CB29 to adapt a mating connector. you are testing connectors that do not plug directly into our standard CB Boards. 	<input type="checkbox"/> Page 37
	<p>Connector Designer™ Connector Editor Software, Item 707 The CableEye connectors library is extensive, and most of the included graphics are of common connectors.</p> <p>Order the Connector Designer module if you need to create your own library of unusual or custom connectors.</p>	<input type="checkbox"/> Page 37
	<p>Custom Reporting & Labeling Software, Item 860 CableEye software includes customizable out-of-the-box reports that meet most of our customers needs. Order the Custom Reporting and Labeling Software if:</p> <ol style="list-style-type: none"> you need to fully customize your own reports or labels by adding your logo or barcodes. you want to modify one of our existing templates. 	<input type="checkbox"/> Page 38
	<p>Custom Labeling Software Only, Item 861 CableEye software includes customizable out-of-the-box basic label printing. Order the Custom Labeling Software if:</p> <ol style="list-style-type: none"> you need to design and print custom labels, that include your logo or barcodes. you need to print color labels. you need to print labels with graphics. 	<input type="checkbox"/> Page 38
	<p>Standalone Software, Item 729 CableEye software requires a tester to be connected to the computer to work.</p> <p>Order the Standalone Software if you need to use the software without a tester connected. You may write macros, create connectors, analyze test data, or perform any function that does not require data acquisition from the tester.</p>	<input type="checkbox"/> Page 38
	<p>Exporter Software, Item 709 Order the Exporter Software if:</p> <ol style="list-style-type: none"> you need to IMPORT cable data from a CSV, XML or EXCEL file. you need to EXPORT cable data to a CSV, XML or EXCEL file. you need to TRANSFER cable data from a Cirris .WIR file. 	<input type="checkbox"/> Page 39
	<p>Applications Programming Interface (API) Software, Item 730 Order the API Software if:</p> <ol style="list-style-type: none"> you need to control the CableEye tester with your custom GUI software interface. you need to control the CableEye tester with LabVIEW™, Visual Basic®, Visual C#® , or other Microsoft®.NET™ scripting languages. 	<input type="checkbox"/> Page 39
	<p>AutoBuild™ Guided Assembly Software, Item 728 Order the AutoBuild Software for guided assembly if:</p> <ol style="list-style-type: none"> you need Assisted Guidance (audio and/or visual) to build your connectors (pinning). you need Assisted Guidance to assemble wire harnesses. you are ordering the Light Director™ accessory. 	<input type="checkbox"/> Page 40

OPTIONAL SOFTWARE for Custom Interfacing

Note: With the exception of the AutoBuild software and Voice Fonts, all optional software comes as a Site License!

Item 708, PinMap™ Fixture Editor Software.....

Use the **PinMap** module to link custom test fixtures, custom CB boards, specially-built connector panels, or pigtail adapters to the **CableEye** software. This software assigns test point numbers to connector types and applies standard pin designations to the pin numbers. For each custom connector, first choose a connector graphic from our large library to match your connector. Then touch the tester's probe to the connector pins one-by-one to automatically detect and assign a test point to each pin. A short beep tone sounds as you touch them so you don't need to take your eyes off the connector you're probing. Finally, enter pin labels of your choice if you wish to override the standard designations. Create custom pin labels of up to seven alphanumeric characters, an especially valuable feature for labeling wiring harness connectors. When you finish probing all pins, you store a "map" file for the custom fixture. A menu within the **CableEye** application lets you easily select the desired map file. Cut and paste connector maps between different map files to mix maps from different **CableEye** CB boards with custom interfaces. Includes a directory of all connector images available in our graphics library. Site license; permits company-wide use with all **CableEye** systems. Note: requires probe! With the exception of the M2U-basic, all testers have a probe port and ship with a probe. *PinMap software is not recommended for use with M2U-Basic testers which neither include a probe nor have a socket to connect one.* **Site License!**

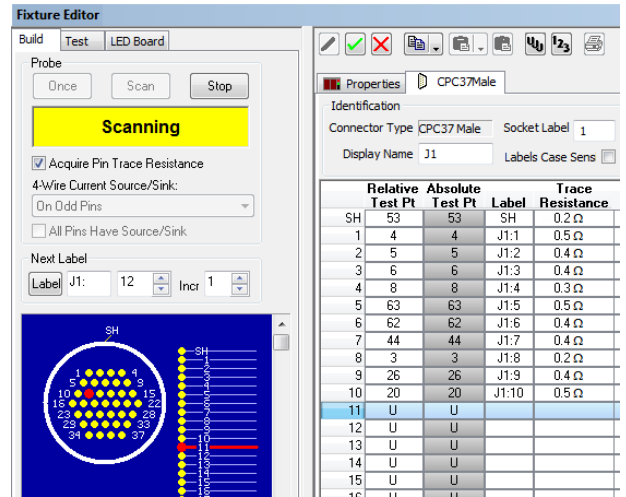

PinMap Screen Shot (Item 708)



Using the Probe when Making a Pin Map

Item 707, Connector Designer™ Connector Editor Software.....

Connector Designer software lets you create custom graphic images for unusual connectors not found in our library. This application aims primarily at the many and varied kinds of circular connectors found in military and aerospace applications and permits you to choose a graphic size, position, and pin numbers, as necessary. The software will create a wire frame image, or will accept your photographic image of a connector in .png or .bmp form as shown on the right over which you may apply the pins, and pin numbering, if pin designations do not appear in the photo. Note that our standard software includes an automatic graphic tool for rectangular, D-shape, and matrix connectors, so for these types of images, you do not need the **Connector Designer** module. However, if you need graphic images for circular or oddly shaped connectors, order the **Connector Designer** software with your system. Site license permits company-wide use with all **CableEye** systems. **Site License!**

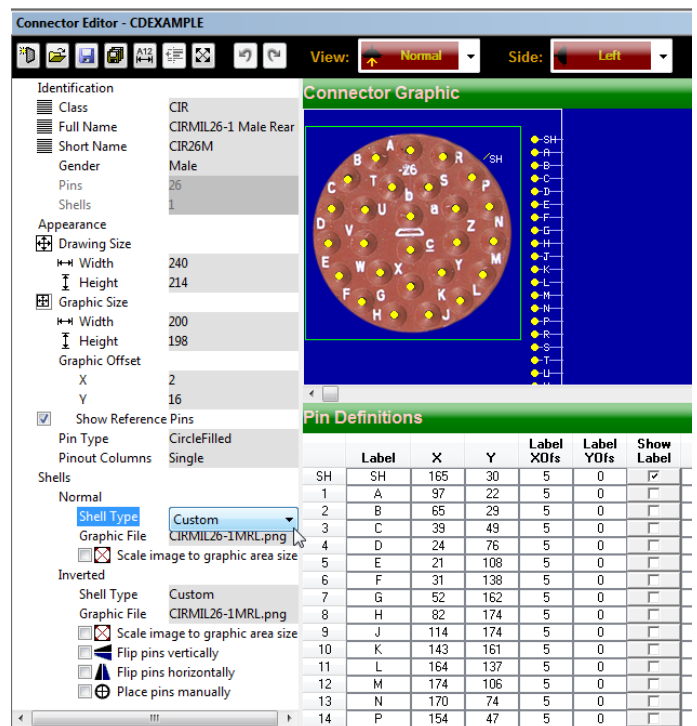

Connector Designer Screen Shot (Item 707)

What's a "Site License"?

When purchasing software with a site license, you purchase it once for ALL of the **CableEye** testers present at your site. The site is defined as your department, business unit, or building, whichever is the more restrictive. If you need this optional software for use at different sites, you must purchase a license for each site in which it will be used.

OPTIONAL SOFTWARE for Custom Reports, Labels, Standalone Operation

Item 860, Custom Reporting and Labeling Option.....

Item 861, Custom Labeling Option Alone.....

The **CableEye** application that comes with each tester includes standard reporting forms for printing a cable's netlist with schematic, a differences list showing wiring errors, a batch report when logging test results, and a report for intermittent connection errors. It also includes a variety of standard label forms you may use for printing cable, carton, or ID labels. Order the Custom Reporting and Labeling Option if you wish to create *fully-customized reports and labels* for special purposes. This option will permit you to add your company logo to each report, bar code fields, custom title blocks, and choose how and where cable data appears on the report. Requires some knowledge of database or **Visual Basic™** form creation. Site license permits company-wide use with all **CableEye** systems. **Site License!**

When using the Labeling Option Alone (Item 861), a simplified setup does not require any prior experience with form creation or labeling programs. Will work with any printer having a Windows driver. Site license permits company-wide use with all **CableEye** systems. **Site License!**

Item 729, Standalone Software License.....

The **CableEye** application software supplied with any tester you purchase requires that the tester be connected to your computer to function. Order this standalone license if you wish to install the software on additional computers and operate it without the **CableEye** test unit being connected. You may find this useful for database management, report printing, label printing, cable design, Macro editing, and log printing. This license also permits installation on a server for company-wide access. When you order this license, your installer CD will include an enabling key for standalone operation. Use this CD to install the software on additional computers, or on your server. (no photo or screen shot available) **Site License!**

VALIDATION PROCEDURE

Item 831, Software Validation Procedure.....

Intended for the main **CableEye** Software, this written procedure with checklist identifies specific software functions to test and gives the expected results to observe. Use this for regression testing to validate software function when installing new releases or meeting standards requirements. Two-hour test by technician familiar with tester operation. Free upgrades on request when the procedure is expanded to reflect the addition of new software functions.

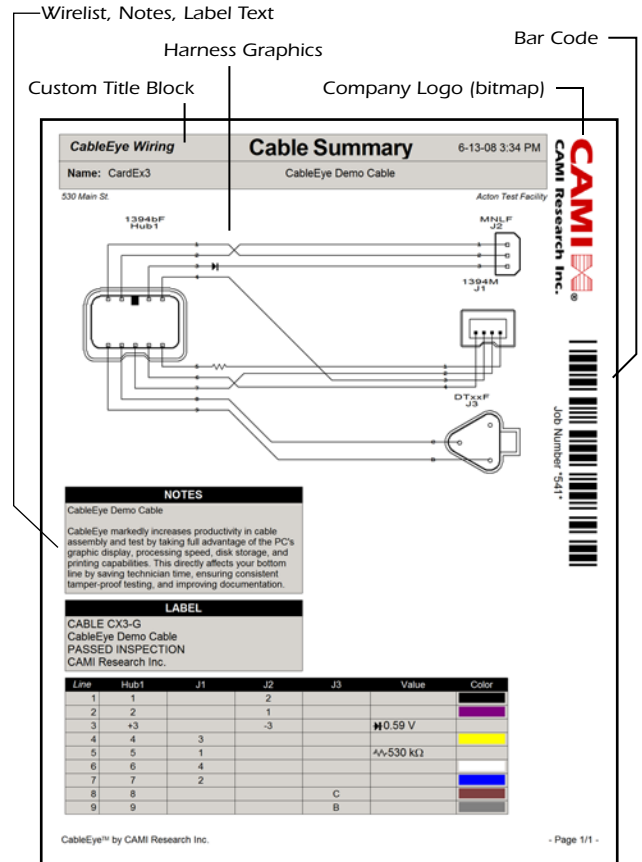

Example Custom Report (Item 860)

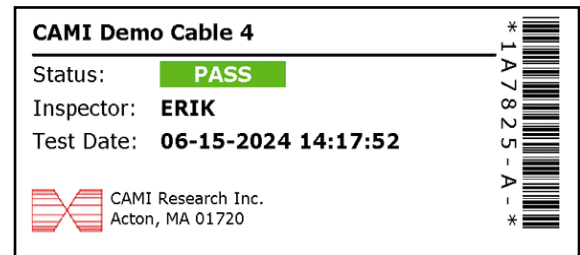

Example Custom Label (Items 860, 861)

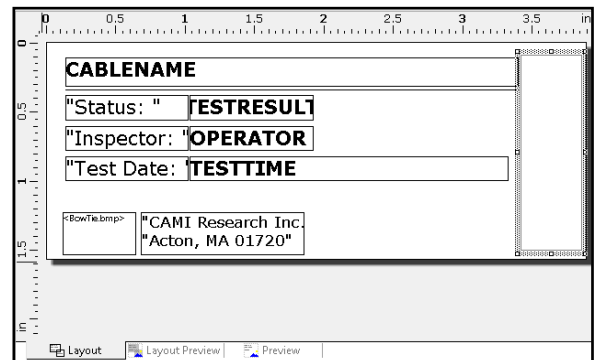

Custom Label Setup Screen (Item 860, 861)

Item 709, Exporter Software

The **CableEye** system stores your custom cable and harness data in its own internal format especially optimized for wirelist searching. Use our Exporter software to export and import cable data in standardized formats. Exported cable data may then easily be imported into commercial database, spreadsheet, or word processor software for custom report generation. You may also import wirelist text back into the internal **CableEye** format. Exported data may be organized in several forms: (a) as a From-To list in which one connection appears on each line; (b) as a Single-Column Pin List in which all connections to a wire appear on one line with connector and pin number individually specified for each connection (good format for large wire harnesses); (c) as a Multi-Column Pin List in which all connections to a wire appear on a single line with pin numbers separated by tabs (or commas) and in order by connector (good format for cables or small wire harnesses).

At present, we support files with tab- and comma-separated fields, or in XML format. We plan to support other more specialized formats in the future. Contact us for further information or to request the addition of a new format. Site license permits company-wide use with all **CableEye** Systems. **Site License!**

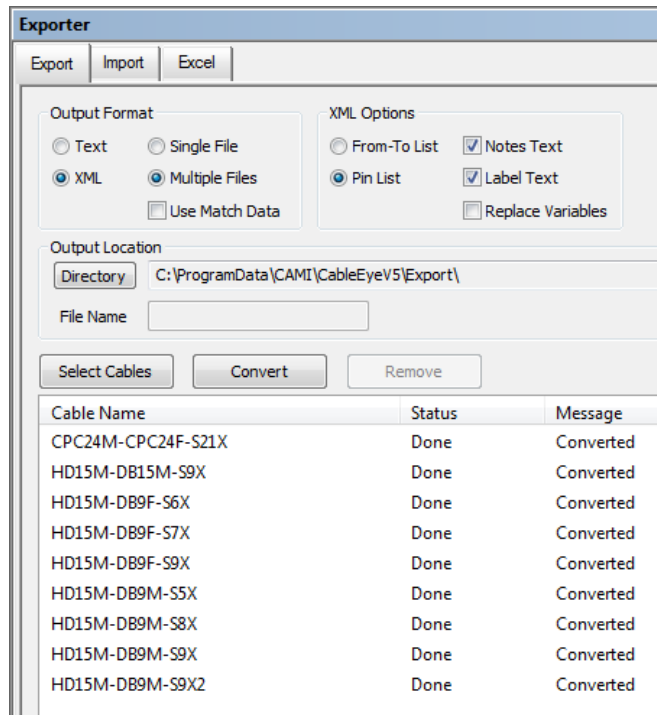

Exporter Software Screen Shot (Items 709)

Item 730, Win32/.NET API Software License with LabVIEW™ Interface.....

The **CableEye** tester normally ships with a complete software application for production, incoming inspection, and R&D. We also offer an optional Application Programming Interface (API), a software library that enables control of the tester by an external program. Using the API, test engineers may now write software for your **CableEye** tester in Visual Basic, C#, any other .NET-based language, or from any other software environment capable of hosting our ActiveX control. We also include a **LabVIEW™** interface that lets you integrate **CableEye** tester control directly into your **LabVIEW** programs.

The API provides a library of software primitives used to exercise control over all basic functions of the tester. This permits engineers to embed the tester's function within a larger system that may include electrical cable lockdown, label printing equipment, pass-fail marking devices, diverter gates, and automatic molding equipment. Engineers may also write their own fully-custom user interface for the tester for special, simplified applications like a touch-screen display.

The API software includes the development environment for creating custom control screens and integration with external software. Runtime modules created with this software may be used without further license fees on any other **CableEye** testers within your organization. We also include the source code for several working examples that you may use as a reference or modify to suit your needs. This option requires some knowledge of programming. **Site License!**

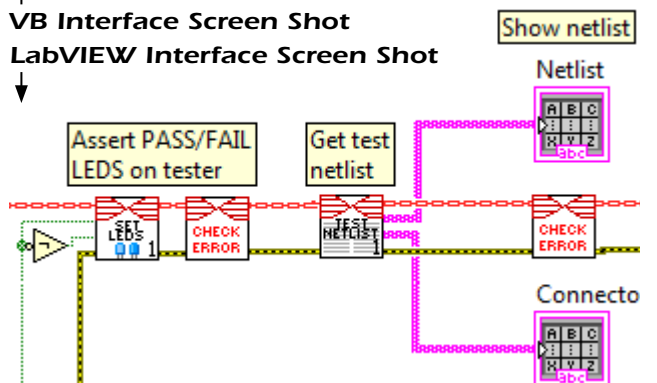
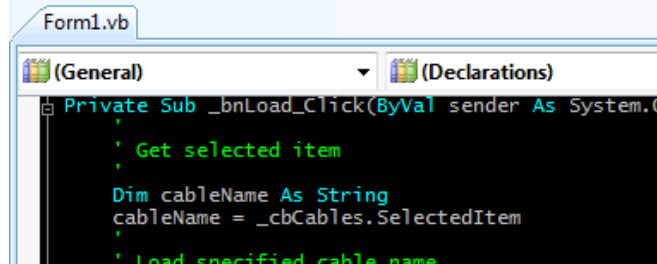
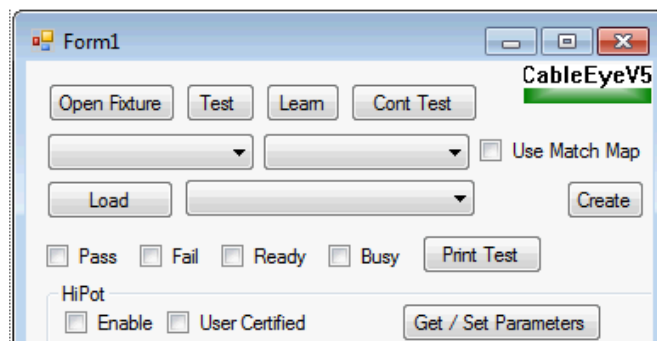

VB Interface Screen Shot
LabVIEW Interface Screen Shot

OPTIONAL SOFTWARE for Guided Assembly and Synthetic Speech

Item 728, **AutoBuild™ Guided Assembly Software**.....

CableEye® AutoBuild™ software provides guided assembly with speech for cable and wire harness manufacturing. You may choose among several modes of operation, depending on the nature of your application. When the far end(s) of the cable or harness can be electrically connected to the tester ("2nd-sided pinning"), the technician touches an unterminated wire using either a probe, or a finger with wrist strap (Item 859, p.43), and the software reads the intended connection point using synthetic speech. The software also shows a connector graphic with the target pin highlighted. Once the connection is made, audible feedback confirms a proper connection or warns of an error.

When the far end of the cable or harness has not yet been assembled or cannot be electrically connected to the tester ("1st-sided pinning"), you may use one of two methods to assist in assembly: (a) blind assembly in which the software reads the next pin to be assembled and shows a graphic of the target pin, but cannot sense insertion (no mating connector necessary); and (b) light-guided assembly in which the mating connector is loaded with LED light fibers to illuminate the target cavity from the inside, thus eliminating the need for a computer screen (requires the **Light Director™** board, Item 767A, p.34). Note that the **Light Director** system has been shown through field testing to improve productivity by at least 30% and up to 50% over manual methods. Refer to our web site for more information on each of these guided assembly methods.

Synthetic speech increases throughput, and helps the technician avoid repetitive motion injury to the neck and shoulders by eliminating the need to look constantly between the workpiece and the videoscreen. A simple half-open headset permits the speech to be easily heard in a noisy environment without interfering with other workers.

When finished, a printed report shows construction time and operator performance. Assembly times and error data may be logged for future study. Programmable tones accompany the graphic screen to give clear signals to the operator when good connections are completed or when incorrect connections, resistance violations, or reversed diode insertions are detected. **Order one AutoBuild option per workstation; this is not a site license. Required for Light Director™ (Item 767A/768A, p30). Video Demonstration on CAMI Web site!**

Note: AutoBuild option is not compatible with M2-Series Models.

Item 792, **AT&T Natural Voices Voice Fonts**.....

These voice fonts may provide clearer, more easily understandable speech than the voice fonts typically included with your **Windows™** operating system. **Order one voice font per workstation; this is not a site license.** Available in various languages:

English:	Item 792A Male	Item 792B Female
Spanish:	(male not available)	Item 792C Female
German:	Item 792D Male	Item 792E Female
French:	Item 792F Male	Item 792G Female



AutoBuild™ Guided Assembly with Speech
Setup for 2nd-Sided pinning with Electrical test.
Target pin highlighted and read aloud. (Item 728)



AutoBuild Screen Image
Setup for 1st-Sided pinning.
Target pin highlighted and read aloud.

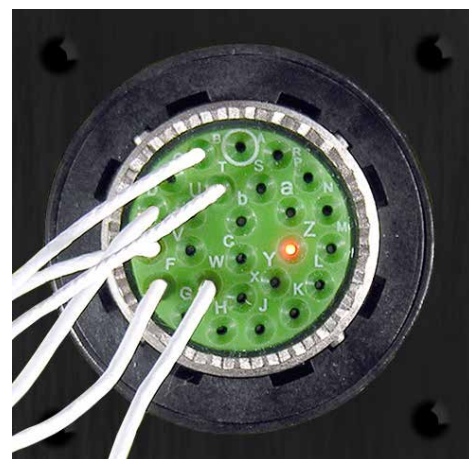

AutoBuild with Light Director Accessory
Setup for 1st-Sided pinning. Target cavity is illuminated from below with LED light fiber.
See "Light-Guided Assembly" on p.34.

ACCESSORIES

Controls, Switches, Sensors

Item 714, Footswitch Control.....

Connects to the REMOTE socket. Functions exactly like the TEST pushbutton and permits hands-free operation during batch testing. Constructed of rugged, heavy-gauge metal for long life in an industrial environment. Secures to a fixed base or floorboard using mounting holes in the base. This low-profile design rises only 0.75" from the floor, and its 2.5" x 3.5" dimensions require little room on your work-area floor. Includes a 10-foot cord with a miniDIN8 connector. *Cannot be used with M2U-Basic/M2Z.*



Footswitch
(Item 714)



Environmental Sensor
(Item 879)

Item 829X, Remote Control Option (HVX-series).....

See details on p.10.

Item 879, Environmental Sensor..... Contact us for details

Temperature, relative humidity, atmospheric pressure sensor with USB int. Includes s/w to read data into **CableEye** variables. Requires software V6.1 B1893 or later.



Item 829X
Optional Remote Control for Dead-Man Switch
Adjustable Exit Direction
(includes connector, wired plugs and instructions)

Cables, Headers, Sockets, Pins

Item 710, Minihook Test Cables (set of two).....

Item 711, Minihook Test Cable (each).....

Allows testing of bare wire terminations. Each cable attaches to your **CableEye** tester with a DB9 connector terminating in 10 color-coded minihook test clips for testing connectorless cables, PC boards, and backplanes. Special connector graphics show a color image of the actual test probes with the measured wiring. Use both probes together, or one probe alone with a connectorized cable at the other end to determine wiring terminations in a sealed connector. **Rated to 500Vdc.** *Requires CB15C (Item 745C) for use.*

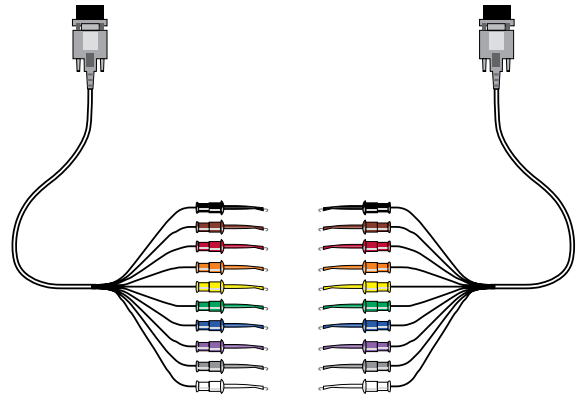

Item 850, 64-pin IDC Socket with Strain Relief.....

Attaches to a 64-conductor flat cable (such as Item 852) to build an extension from the 64-pin headers on the **CableEye** tester.



64-Pin IDC Socket
(Item 850)

Item 851, 64-pin Vertical IDC Boardmount Header with Ejection Latches (PCB mount).....

Interfaces custom PCB connector fixtures of your own design, or mounts in the "Custom" position of the CB2 or CB2A boards (Items 732 and 732A) for testing 64-conductor flat cable. Identical to the connectors used on **CableEye** control modules (for example, Item 826).



64-Pin Vertical Boardmount Header
PCB Pins
(Item 851)



64-Pin Right-Angle Boardmount Header
PCB Pins
(Item 851R)

Item 851R, 64-pin Right-Angle IDC Boardmount Header with Ejection Latches (PCB mount).....

Like Item 851, this header interfaces custom PCB connector fixtures of your own design but mounts at a right angle to the PC board (connector pins parallel to PCB surface). Identical to the 64-pin connectors used on **CableEye** attached expansion modules (for example, Item 827).



64-Conductor Flat Cable
(Item 852)

Item 852, 64-conductor IDC Flat Cable.....

For use with IDC connectors (Items 850 and 853), not included. Available in spools of 250 feet; inquire about spool price. **Rated to 500 V dc/ac.** Orders for custom lengths are **NC NR**.

NC - Non-Cancellable
NR - Non-Returnable

ACCESSORIES *(continued)*

Item 853, 64-pin Vertical Surface-Mount IDC Header with Ejection Latches and Mounting Brackets.....

Mounts on harness boards or other flat surfaces to link mating connectors to a removable 64-conductor flat cable.

Item 854X, Custom 64-Conductor Pre-Assembled Cable

64-pin IDC header at each end; assembled, tested. For applications needing a connector at just one end, order twice the length needed and cut in half. Min. length 3". Min. charge as for 6" length. Surcharge* applies for **QuickMount** Housing cables. **Rated to 500 V dc/ac**. Orders for these custom products are **NC NR**.

Item 855, 64-pin Boardmount Socket.....

Use this connector to interface custom-designed CB boards to the **CableEye** control module or **QuickMount** Housing (Item 712H, p.9). Min. order \$50 by purchase order, or Qty 2 by credit card.

Item 856X, CB Board Extension Cable

To test cables less than 5" long, remove one CB board from the fixture and electrically reconnect it using this 64-conductor extension cable. You may then position the free-floating CB board as close to the second CB board as necessary to accommodate short test cables; see photo. Standard length is 12". Custom lengths available. Min. length 6". **Rated to 500 V dc/ac**. Orders for custom lengths are **NC NR**.

Item 862, 80-pin Bare Header with Breakaway Pins

Use in CB2 boards for custom configuration or any application that accepts 0.025" square posts on a 0.1" x 0.1" grid.

Item 863, AMPMODU™ Socket Body and Pins

Consists of a 64-pin socket body with open cavities and a kit of 65 gold-plated female crimp pins (64 plus 1 extra) for 22-26 gauge wire. When assembled, this socket plugs into any of the 64-pin headers used on **CableEye** testers or expansion modules and would be employed when building rugged custom interfaces where IDC flat cable would be inappropriate, or where test voltages up to 2100 Vdc or 1200 Vac must be sustained. Crimp pins suitable for other gauge sizes or with different plating are available; contact us for information. *Note: appropriate crimping tool required!*

Item 864, Custom 64-Conductor Pre-Assembled AMPMODU™ Cable.....

We use two **AMPMODU** 64-pin sockets as described above to build a female-to-female cable with discrete wire. Crimped gold contacts ensure low-resistance, strain-relief connections. Custom-assembled to your specified length. Recommended when test voltages exceed 500V or for high accuracy resistance measurements regardless of applied voltage. Min. 6". Max. 6ft. Surcharge* applies for **QuickMount** Housing cables. **Rated to 2100 Vdc/ 1200 Vac**. Orders for these custom products are **NC NR**.

NC - Non-Cancellable
NR - Non-Returnable

64-Pin Surface-Mount Header (IDC)
(Item 853)



64-Conductor Pre-Assembled Cable
(Item 854X)



64-Pin Boardmount Socket
(Item 855)
Item 855 mounted to **CableEye** CB board



CB Board Extension Cable (Item 856)



80-Pin Vertical Bare Header with Breakaway Pins
(Item 862)



AMPMODU Socket Body and Pins
(Item 863)



AMPMODU Cable 64-Pin, Assembled
(Item 864)

NOTE: CAMI cables can be factory certified at high voltage for a service fee.

* Contact us for a quote

Header Isolator™ Adapter Sets

Header Isolator™ protective adapters protect the built-in 64-pin headers of your tester from contamination as well as from bent pins and wear when there is repeated connection and disconnection of CB boards or cables. Recommended especially for M4 and HVX with Advanced Measurement option because of increased resistance sensitivity of those models. Takes only moments to replace a damaged or worn adapter while tester remains on the production line.

Item 755A, CB25A Header Isolator™ Riser Board Set

For operation beyond 1500V, certification fee required.
Use with your CB boards. Required as a Riser Board when attaching a CB35 interface fixture to the top of an HVX-series control module. **Rated to 2100 Vdc/1200 Vac.** [2]

Item 778A, CB48A Header Isolator™ Set, Vertical Header
Rated to 2100 Vdc/1200 Vac

For operation beyond 1500V, certification fee required.
Attach CB48A adapters to the 64-pin headers of a control module or to HVX-series expansion modules. Connect cables directly to the adapters. Not compatible with 64-pin headers of M-series expansion modules; use Item 868 instead. [2]

Item 778B, CB48B Header Isolator™ Set, Right-Angle Header
Rated to 2100 Vdc/1200 Vac

For operation beyond 1500V, certification fee required.
Attach CB48B adapters to the 64-pin headers of a control module. Connect cables directly to the adapters. [2]

Item 868, 64-pin Header Isolator™ Set.....

Attach these adapters to the 64-pin headers of your M-series tester (control and expansion modules). Connect cables directly to the adapters. **Rated to 500 V dc/ac Max.** Can be factory certified for operation at max. rated voltage for a service fee. [2]

Probes

Probe devices connect to the right side of the tester and are used to identify flying pins or bare wires. Use with the **CableEye** Probe function, **AutoBUILD** guided assembly software (Item 728, p.40), and **PinMap** software (Item 708, p.37). Available for all models excluding the M2U-basic.

Items 718/719 Probe Cable (DB9/Banana Jack)

All new testers ship with a probe. Order this item as a replacement or an extra.

Item 859B Wrist Strap (Banana Jack).....

Touch wires, pins, or electrical contacts of interest with your fingers, freeing the hand that would normally hold a probe. A 1 MΩ resistor isolates the body contact from the tester but allows sufficient current to flow for detection.

Item 878, Probe Plate Fixture.....

This standalone fixture features a 0.5" probe plate, ships with an 18" cable, and includes a 9/64" (.140") mounting hole for attaching to your equipment, bench or harness board. For integrated probe plates, see p.31.

Header Isolator™ is a trademark of CAMI Research Inc.



CB25A
Riser Board Serves as **Header Isolator** Adapter for CB Boards



CB48A
Header Isolator Vertical Adapter (Item 778A)



CB48B
Header Isolator Right-Angle Adapter (Item 778B)



CB48 A (Front) and B (Top) Installed on an HVX Tester.



64-Pin Header Isolator Protective Adapter (Item 868)



Probe Cable (Item 718)

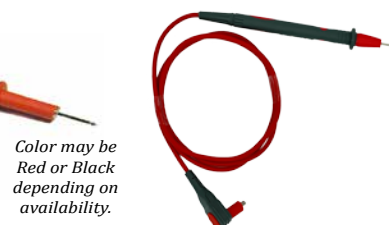

Color may be Red or Black depending on availability.



Probe Plate Fixture (Item 878)



Wrist Strap (Item 859B)

NOTE: Unless specified otherwise, CB boards on this page are rated for operation at 500 V dc/ac. CAMI boards can be factory certified for operation at the maximum board-rated voltage for a service fee.

ACCESSORIES (continued)

Power Modules

Item 701U, M2-Series Power Module

Provides 9 Vdc at 1.3 A for operation of the **CableEye** hardware. Input 100-240 Vac, 50-60 Hz. USA prongs. Lightweight, efficient switching regulator.

Item 703U, M3-Series, M4 Power Module.....

Provides 18 Vdc at 1.0A for operation of the **CableEye** hardware. Input: 100-240 Vac, 50-60 Hz. USA prongs. Lightweight, efficient switching regulator.

Items 706E, 706B, 706A, Power Module Prong Adapters for Europe, the UK, and Australia (respectively)

Adapts wall-module prongs to appropriate country standard. This is an additional charge if we replace the USA prongs with the prongs intended for the listed countries.

Item 721B, 3.3A Power Supply for 640+ TP expanded systems up to 2560 TP Systems

Provides 18 Vdc regulated output for M3-Series and M4 testers with Expansion Modules. Input 100-240 Vac, 50-60 Hz. Standard IEN 3-prong equipment socket accepts power cords from any country. Power cord provided for USA and Europe plugs. *Power cord not included for UK or Australia.*



M2- and M3-Series Switch-Mode Power Supply
(Item 701U or 703U)

Prong Adapters for Europe, UK, and Australia
(Item 706)



Regulated Desktop Power Supply
(Item 721B)



Tilt Stand, Labels

Item 857, Tilt Stand for Control Module.....

Mount these two sturdy aluminum brackets to the base of low voltage series testers to tilt the unit forward at a 30° angle. Rubber feet protect the table top, and holes in the bottom flange of these brackets permit them to be bolted to the work table if desired. May be used with expansion modules attached. Recommend for high-volume production stations or when using our **Light Director™** connector assembly system (p.34). Will not work with older model M2U-Basic testers (Item 810U) having serial numbers earlier than 004350. Includes two brackets, screws, and installation instructions.



Control Module Tilt Stand
(Item 857)

Item 712A, Tilt Stand for QuickMount™ Housing.....

A variant of item 857. For details see p.9.



QuickMount™ Tilt Stand Brackets (Item 712A)

Item 876, QC Labels

A trust indicator: Apply to a product to show your customers that it passed an electrical test with a high quality tester. Self adhesive, 0.5" dia. labels, on rolls. Graphic is 0.4" dia.



QC Labels
(Item 876)

Storage, Transportation

Item 725, CB Board Storage Rack.....

Conveniently store CB connector boards not in use. Twenty slots will hold between ten and twenty boards; certain boards, such as CB4, require two positions because of the height of the connectors. This 7" x 20" rack is made of rugged red or black plastic, weighs 2 lbs, and has carrying handles on the front and rear.

CB Board Storage Rack
(Item 725)



NOTE: Color may be Red or Black, depending on availability.

ACCESSORIES *(continued)*

Pelican™ Carrying Cases, 704/C/D/G/H/K

Rugged, watertight, dustproof and corrosion proof case. Highly recommended for LV systems with 7 or more expansion modules, and all HVX systems. Foam-lined. Pressure equalization valve. *Manufacturer's lifetime guarantee.* Dent- and shatter-resistant HPX resin case includes two padlockable hasps. 704C/D/G/K are rolling cases with extendable handles.

Item 704C, Rolling Case (HVX-Series up to 256TP).....

Item 704D, Rolling Case (HVX-Series up to 512TP).....

Item 704G, Rolling Case (M-Series ≥ 512TP).....

Item 704H, (M-Series up to 256TP).....

Item 704K, Rolling Case, (M-Series Testers - 384 or 512TP).....

See Item 704C, D, G, H, K on Page 11 for further details.



Highly recommended for all HVX systems and for LV systems with 7 or more expansion modules.

Item 877, HVX-Series Protective Cover.. contact us for pricing

Antistatic, water-resistant, dust cover in frosty clear taffeta vinyl with red trim. A cover for every stack height.



HVX-Series Protective Cover (Item 877)

Item	Series:# Exp Modules	Ext. Dims (LxWxD)	Certifications
C*†	HVX: 0,1	24.60" x 19.70" x 11.70"	ATA 300 Cat. 1
D*†	HVX: 2,3	24.60" x 19.70" x 14.40"	FED-STD-101C
G*†	M: ≥ 4	24.60" x 19.70" x 14.40"	MIL-STD-810F
H†	M: 0,1	19.2" x 15.2" x 7.30"	MIL-STD-648C
K*†	M: 2,3	21.70" x 14.10" x 8.90"	

*Rolling case with extendable handle
 †Meets ATA 300 category 1 standards for transit cases, FED-STD-101C requirements for drops and vibration (loose cargo), MIL-STD-810F for immersion and simulated rainfall, and exceeds specs. listed in MIL-STD-648C for vibration (sweep).

Rolling Pelican Case (Item 704C,D,G,K)



Pelican Carrying Case (Item 704H)



Rolling Pelican Carrying Case (Item 704K)

SERVICE

Extended Product Support Subscription

Comprising Software and Hardware Maintenance, Technical Support, Warranty, and more

- Item 700, 1-Yr Standard Product Support Subscription, M2, M3, M4.....
- Item 700E, Units with 1-7 Expansion Modules.....
- Item 700E8, Units with 8+ Expansion Modules.....

- Item 700H, 1-Yr Standard Product Support Subscription, HVX series.....
- Item 700HE, Units with 1-3 Expansion Modules.....
- Item 700HX, Units with 4+ Expansion Modules.....

- Item 700L, 1-Yr Product Support Subscription, HVX Limited Warranty.....
- Item 700LE, Units with 1-3 Expansion Modules.....
- Item 700LX, Units with 4+ Expansion Modules.....

- Item 700EL, Special Handling: End of Life Unit..... 10%

SOFTWARE DOWNLOADS

If your system is under a Product Support Subscription, use the link to download your complimentary software updates.

support.camiresearch.com/mysoftware

WARRANTY REPAIRS

Refer to

camiresearch.com/repairs

when you suspect a tester error. Follow the instructions for when and how to send your tester for repair.

Product Support Subscription Summary

- 1 - Renewable one-year subscription
- 2 - Free software maintenance (free update/upgrade downloads)
- 3 - Free Tech Support (includes 1 hr virtual, instructor-led training) ^{a,b}
- 4 - Discounted pricing on CAMI customization services
- 5 - Complimentary loaner tester ^{c,g}
- 6 - Access to for-fee expedite service ^d
- 7 - Remote connection to your tester for diagnostics and guidance ^e
- 8 - Free repair of unprovoked hardware failures (parts & labor) ^{f,g}

Product Support Subscription details:
camiresearch.com/advantage

- ▶ Subscription NOT req'd for tester operation.
- ▶ Except for custom s/w and interfaces, new testers include Product Support Subscription.
- ▶ If tester or subscription was bought from Intl. Distributor, contact them for subscr. matters and service.

NOTES

- a) Limited to questions about setup or operation, or those concerning test function, reports, or external factors affecting the function of the equipment and software. Excludes consultation.
- b) For additional training, see camiresearch.com/training.
- c) Subject to availability. Limited supply is reserved for subscribed testers.
- d) Contact us at least 1 wk in advance to request and book this service. Next day inbound and return shipment is required: You must arrange for your tester to arrive here by 10:30am EST the morning of the scheduled date, and specify next day air service or one-day ground return shipment on

your PO. See our service pages for details on lead times. Not available for HVX repair service or unsubscribed testers. Applicable service costs, shipping, and expedite fee are not included with the subscription.

- e) **CableEye** software menu has a quicklink to CAMI's TeamViewer service.
- f) Included when all **CableEye** testers under ownership by the customer are covered by a Product Support Subscription. Connector replacement x1 only per board.
- g) Customer pays shipping costs.

See what our customers have to say about our support:

"The support we have received from CAMI has been excellent. Post sales support has made a great product truly excellent."

M.D., VP - Northcomm Technologies

"CAMI Research has some of the best customer support and response times of any of our vendors, and I want you to know that this is truly and sincerely appreciated."

W.R. - Roanwell Corp.

"CAMI Research's customer service is also second to none. I know that they are there to guide me if I have a question about a feature I haven't already used and am working to implement."

E.J. - Heitek Automation

"CAMI has been a fantastic partner in this process from inception to implementation with fantastic service. With their tech support and service warranties [Product Support Subscriptions] keeping the software up to date, CAMI has been great to work with all the way."

J.K., Strategic Asset Director - Production Resource Group

"We are very impressed with the design and versatility of the CableEye cable tester. The technical support is second to none. We are also pleased with CAMI's willingness and ability to support those who are working with unique testing requirements. I strongly recommend this cable testing system!"

R.S., President - Positron Corporation

Calibration

Item 717, M3, M4 Series Calibration (control module alone).....

Item 717E, Units with 1-7 Expansion Modules.....

Item 717E8, Units with 8+ Expansion Modules.....

Item 717H, HVX Series Calibration (control module alone).....

Item 717HE, HVX Series Calibration (1-3 expansion modules).....

Item 717H4, HVX Series Calibration (4+ expansion modules).....

Item 700EL, Special Handling: End of Life Unit..... 10%

We recommend calibration of **CableEye** Model M3, M4 or HVX-Series testers yearly. All HVX series testers undergo a general inspection and cleaning before calibration. Our trained experts remove the cover (not otherwise necessary for calibration alone), inspect, clean, and check for the need to install any applicable firmware upgrades (three microcontrollers inside).

Follow service instructions at camiresearch.com/calibration for ordering and shipping. We will normally complete the calibration and return ship to you within 1-2 business days for low voltage testers and 2-4 business days for high voltage testers. A Calibration Certificate with data is included for your records.

Calibration kits are available. Contact us for details.

► Refer to our website for further detail:
**CableEye Calibration:
Why, When, and How**
camiresearch.com/calibration

► Note: **CableEye** M2-Series testers do not require calibration!

Software Upgrade

Item 726, **CableEye** Software Upgrade (for v5.5 or earlier, no tech support available without an active Product Support Subscription).....

Item 726A, **CableEye** Software Upgrade (for v5.5 or earlier, only if renewing Product Support Subscription at the same time, see previous page).....

Item 726B, **CableEye** Software Upgrade (from v6.0 or later).....

This item is for customers who own **CableEye** equipment with outdated software. The software upgrade includes installation instructions, *and* upgrades any optional software previously purchased with your system such as **PinMap**, **Connector Designer**, or **AutoBuild**.

Item 726C, **CableEye** Software Upgrade for Multiple Testers.....
..... (discounted price, contact us for a quotation)

For companies with two or more **CableEye** testers currently running obsolete software, **upgrade all testers at one time** at a discounted price. Contact us with the serial numbers of your testers for a quotation. All testers owned by your company must be upgraded to qualify for a discount.

► Refer to our website for further detail and to check for the most current version of software:
camiresearch.com/software-upgrade

Hardware Upgrade

CableEye testers are future-ready. System capabilities can be expanded post-purchase by adding software and/or hardware options (shown elsewhere in catalog). CAMI and several of its worldwide, authorized distributors offer these upgrade services making it easy for users to modernize their testers, and to add functionality to meet growing business demands and changing needs. Software upgrades are near instantaneous, and are described above.

► Refer to our website for further detail and follow the service instructions for ordering and shipping:
camiresearch.com/upgrade

CABLEEYE AUTOMATION

MACROS:

The simplest, easiest scripting language on the market.

Setup your test station to perform multiple background tasks, all triggered automatically with a single click of a button. Easily control the workflow of your test with Macros, our built-in scripting language.



- Input Custom Data.
- Type in or Scan Work Order Information.
- Store the Data with the Cable.
- Display the Data in Reports.

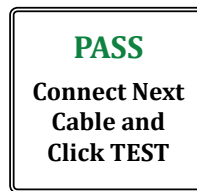

- Display work instructions.
- Use full color images.
- Customize your operator messages with colors, different font size, tables, and many more options.



Control tower lights, locks, PLCs, counters, pistons or any other device for a continuous, high quality test workflow.



- Get test results.
- Perform operations based on test result.
- Easily analyze errors in the cable with our amazing graphics and netlist.



- Print PASS or FAIL reports *and* labels.
- Print your custom data, work order, serial number, etc.
- Use any Windows-compatible printer.

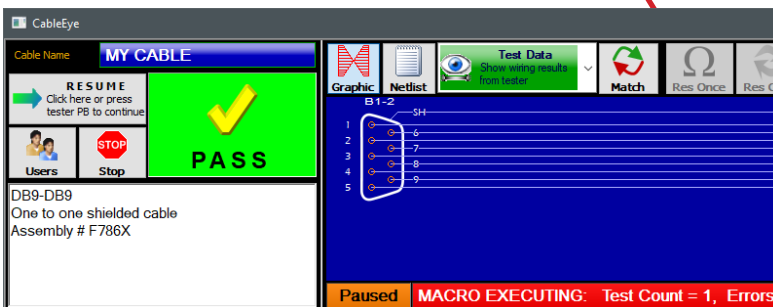

- Store data locally or on the network.
- Generate full color PDF files for easy sharing of reports with your customers.
- Backup and Restore your data with our simple to use Backup Utility.

The production screen allows the operator to easily identify wire problems if required, or simply follow on-screen instructions.

API integration with other equipment or software. **LabVIEW** and **.NET** libraries available.

camiresearch.com/automation.html

Automation is simple, yet powerful with CableEye Testers.

Included with every tester, **CableEye** software offers out-of-the-box automation capabilities with both **Macros** and **JavaScript** scripting languages. By completely automating the test process after the operator attaches a cable, you eliminate any chance that testing or documentation will differ from one cable to the next. With **CableEye** testers you can:

The CB35 Relay Board allows you to manage external devices for full control and automation of your test station.

It offers 10 relay outputs and you can cascade as many boards as needed. Check our **CB35** Relay Board on p.27

